



Professional Tools



Contact Us

Sales-
+91 9811579961

Varun Tiwari-
+91 8595503657

Sushil Mishra-
+91 7011218105

Phone-
011-47002673

Email Us

staplespackagingsolutions@gmail.com

Visit Our Website

spspneumatictools.com

LITHIUM-ION BATTERY TOOLS

Same Battery 580+ tools **P20S**



CORDED POWER TOOLS

BENCH TOOLS



GENERATORS

WELDING MACHINE



SMALL CONSTRUCTION EQUIPMENT



AIR TOOLS



GARDEN TOOLS



WATER PUMPS



POWER TOOLS ACCESSORIES



HAND TOOLS



MEASURING TOOLS



SAFETY PRODUCTS



Cordless screwdriver
CSDLI0442

Voltage: 4V
 Hex shank: 1/4"
 No-load speed: 240rpm
 Max torque: 4Nm
 Two positions adjustable handle
 Charging via USB type-C cable(cable sold separately)
 Integrated work light
 Include:
 16 Pcs 25mm Cr-V bits+holder
 2 Pcs 50mm Cr-V bits+holder, 1 Pcs connector
 Packed by carrying case



LIST PRICE	Qty/Ctn
1532	20

Cordless screwdriver
CSDLI0802

Voltage: 8V
 Hex shank:6.35mm(1/4")
 No-load speed: 220rpm, Max.torque: 6Nm,
 Torque settings: 15+1
 Two positions adjustable handle
 Charging via USB type-C cable(cable sold separately)
 Integrated LED work light
 Include: 10 Pcs 25mm Cr-V bits+holder (SL4 \SL6\PH1\PH2\PH3\PZ1\PZ2\PZ3\T20\T25)
 1 Pcs 60mm connector, 4 Pcs HSS drill bits with Hex shank(2.0\2.5\3.0\4.0), 1 Pcs CRV PH2, 1 Pcs CRV 6
 Packed by canvas bag



LIST PRICE	Qty/Ctn
3016	20

Cordless drill
CDLI 124 15

Voltage:12V
 No-load speed:0-750rpm
 Max torque:20Nm
 Chuck capacity:0.8-10mm
 Torque settings:15+1
 Integrated LED work light
 Include:
 1 Pcs Cr-V 65mm bit
 1 Pcs 1.5Ah battery pack(FBLI12152)
 1 Pcs charger(FCL12071), Charge volts: 220-240V~50/60Hz
 Packed by color box



LIST PRICE	Qty/Ctn
3038	10

Cordless drill
CDLI 122 08

Voltage:12V
 No-load speed:0-400/0-1500rpm
 Max torque:20Nm
 Chuck capacity:0.8-10mm
 Torque settings:15+1
 Mechanical 2-speed gear
 Include:
 1 Pcs Cr-V 65mm bit
 2Pcs 1.5Ah battery pack(FBLI12152), 1 Pcs charger(FCL12071)
 Charge volts: 220-240V~50/60Hz , Integrated work light
 Packed by carrying case



LIST PRICE	Qty/Ctn
4402	5

Lithium-Ion battery pack
FBL I12 15 2

Voltage:12V
 Lithium-ion 1.5Ah battery
 One battery fits all S12 multiple tools
 Packed by color box



LIST PRICE	Qty/Ctn
1885	20

S12 battery charger
FCL I12 07 1

Input voltage:220-240V~50/60Hz
 Output voltage:12V
 Output current:0.65A
 Packed by color box



LIST PRICE	Qty/Ctn
469	20

Cordless drill
CDLI 121 1

Voltage:12V
 No-load speed:0-750rpm
 Max torque:20Nm
 Chuck capacity:0.8-10mm
 Torque settings:15+1
 Include:
 1 Pcs Cr-V 65mm bit
 1 Pcs 1.5Ah battery pack(FBLI12151)
 1 Pcs charger(FCL12071)
 Charge volts:220-240V~50/60Hz
 Integrated work light
 LED battery power indicator
 Packed by color box



LIST PRICE	Qty/Ctn
3924	10

Cordless drill
CDLI 121 8

Voltage:12V
 No-load speed:0-750rpm
 Max torque:20Nm
 Plastic chuck
 Chuck capacity:0.8-10mm, Torque settings:15+1
 Integrated work light
 LED battery power indicator
 Include:
 1pcs 1.5Ah battery pack(FBLI12151), 1pcs charger(FCL12071)
 Charge Volts:220-240V~50/60Hz , 1pcs Cr-V 65mm bit
 Packed by color box



LIST PRICE	Qty/Ctn
2905	10

Lithium-Ion battery pack
FBL I12 15 1

Voltage:12V
 Lithium-ion 1.5Ah battery
 LED battery power indicator
 Packed by color box



LIST PRICE	Qty/Ctn
1698	20

Cordless drill
CDLI 200 51

Voltage:20V
 No-load speed:0-400/0-1500rpm
 Max torque:45Nm
 Chuck capacity:0.8-10mm
 Torque settings:15+1
 Mechanical 2-speed gear
 Include:
 1 Pcs Cr-V 65mm bit, 1 Pcs 1.5Ah battery pack(FBLI20015)
 1 Pcs charger(FCL2001), Charge volts: 220-240V~50/60Hz
 Integrated work light, LED battery power indicator
 Packed by color box



LIST PRICE	Qty/Ctn
4834	5

Cordless drill
CDLI20028

Voltage:20V
 No-load speed:0-400/0-1500rpm
 Max torque:45Nm
 Chuck capacity:0.8-10mm
 Torque settings:15+1
 Mechanical 2-speed gear
 Include:
 1 Pcs Cr-V 65mm bit, 2 Pcs 1.5Ah battery pack(FBLI20015)
 1 Pcs charger(FCLI2001), Charge volts: 220-240V~50/60Hz
 Integrated work light, LED battery power indicator
 Packed by carrying case

LIST PRICE	Qty/Ctn
7000	5

Cordless drill
CDLI 200 51 8

Voltage: 20V
 No-load speed: 0-400/0-1500rpm
 Max torque: 45Nm, Plastic chuck
 Chuck capacity: 0.8-10mm, Torque settings: 15+1
 Mechanical 2-speed gear, Spindle lock function
 Integrated LED work light, LED battery power indicator
 Include:
 1 Pcs 2.0Ah battery pack(FBLI20011), 1 Pcs charger(FCLI2001)
 Charge volts: 220-240V~50/60Hz, 1 Pcs Cr-V 65mm bit

LIST PRICE	Qty/Ctn
5201	5

Cordless drill
CDLI 200 52 8

Voltage: 20V
 No-load speed: 0-400/0-1500rpm
 Max torque: 45Nm
 Plastic chuck, Chuck capacity: 0.8-10mm
 Torque settings: 15+1, Mechanical 2-speed gear
 Spindle lock function, Integrated LED work light
 Include:
 47 Pcs accessories, 2 Pcs 2.0Ah battery pack (FBLI20011)
 1 Pcs charger(FCLI2001), Charge volts: 220-240V~50/60Hz
 Packed by carrying case

LIST PRICE	Qty/Ctn
7528	5

Compact Brushless Cordless Drill
CDLI 206 02 1

Brushless motor
 Voltage: 20V
 No-load speed: 0-550/0-2000rpm
 Max torque: 60Nm
 Metal chuck
 Chuck capacity: 13mm(1/2")
 Torque settings: 22+1
 Auto-lock keyless chuck
 Mechanical 2-speed gear
 Spindle lock function
 Integrated LED work light
 Include:
 1 Pcs Cr-V 65mm bit
 Charger sold separately

LIST PRICE	Qty/Ctn
3846	5

Compact Brushless Cordless Drill
CDLI 206 02

Brushless motor
 Voltage: 20V
 No-load speed: 0-550/0-2000rpm, Max torque: 60Nm
 Metal chuck, Chuck capacity: 13mm
 Torque settings: 22+1, Auto-lock keyless chuck
 Mechanical 2-speed gear, Spindle lock function
 Integrated LED work light, LED battery power indicator
 Include:
 2 Pcs 2.0Ah battery pack(FBLI20011), 1 Pcs charger(FCLI2001)

LIST PRICE	Qty/Ctn
8438	5

Cordless impact drill
CIDLI 20 14 52

Voltage: 20V
 No-load speed: 0-400/0-1500rpm
 Max impact rate: 22500bpm
 Max torque: 45Nm
 Metal chuck
 Chuck capacity: 0.8-10mm
 Torque settings: 18+1+1
 Mechanical 2-speed gear
 Spindle lock function
 Auto-lock keyless chuck
 Include:
 47 Pcs accessories
 3 Pcs masonry drill bits
 2 Pcs 2.0Ah battery pack(FBLI20011)

LIST PRICE	Qty/Ctn
8904	5

Compact Brushless Cordless Impact Drill
CIDLI 20 60 2

Brushless motor
 Voltage: 20V
 No-load speed: 0-550/0-2000rpm
 Max impact rate: 30000bpm
 Max torque: 60Nm, Metal chuck, Chuck capacity: 13mm
 Torque settings: 22+1+1, Mechanical 2-speed gear
 Spindle lock function, Auto-lock keyless chuck
 Integrated work light, LED battery power indicator
 Include: 2 Pcs 2.0Ah battery pack(FBLI20011), 1 Pcs charger(FCLI2001), Charge volts: 220-240V~50/60Hz,

LIST PRICE	Qty/Ctn
8992	5

Cordless impact drill
CIDLI 20 02 15

Voltage:20V
 No-load speed:0-400/0-1500rpm
 Max impact rate:22500rpm
 Max torque:45Nm
 Chuck capacity:0.8-10mm
 Torque settings:18+1+1
 Mechanical 2-speed gear
 Include:
 1 Pcs Cr-V 65mm bit
 3 Pcs masonry drill bits
 2 Pcs 2.0Ah battery pack(FBLI2001)
 1 Pcs charger(FCLI2001E)
 Charge volts:220-240V~50/60Hz
 Integrated work light

LIST PRICE	Qty/Ctn
10750	5

Cordless 2 Pcs combo kit
COSLI 23 011

Voltage:20V
 With 1 pcs lithium-ion impact wrench (CIWLI2038)
 With 1 pcs work lamp(HWLI35261)
 Lithium-ion impact wrench(CIWLI2038):
 Brushless motor, Voltage:20V, Square drive:1/2"
 No-load speed:0-1300/0-2300rpm, Impact rate:0-2000/0-3300bpm
 Max torque:300Nm, Integrated LED work light
 Work lamp(HWLI35261)
 Using Li-polymer rechargeable battery
 Lumens: Max:300±10%, Low:75±10%
 LED power dissipation:3.5W

LIST PRICE	Qty/Ctn
10828	6

Cordless impact wrench
CIWLI 20 01

Brushless motor
 Voltage:20V
 Square drive:1/2"
 No-load speed:0-1300/0-2100rpm
 Impact rate:0-2000/0-3300bpm
 Max torque:300Nm
 Integrated LED work light
 Include:
 3 Pcs sockets(17,19,21mm)
 1 Pcs belt clip
 2 Pcs 2.0Ah battery pack(FBLI2001)
 1 Pcs charger(FCLI2001E)
 Charge volts:220-240V~50/60Hz
 Packed by canvas bag

LIST PRICE	Qty/Ctn
10846	5



Cordless impact wrench

CIWL12040

Brushless motor
 Square drive: 1/2"
 No-load speed: 0-1600/0-1900/0-2300rpm
 Impact rate: 0-2100/0-2500/0-2900bpm
 Fastening torque: 400Nm
 Nut-Busting torque: 550Nm
 Integrated LED work light
 Include:
 1 Pcs 20V charger(FCLI2001)
 Charge volts: 220-240V-50/60Hz
 2 Pcs 2.0Ah battery pack(FBLI20011)
 3 Pcs sockets(17,19,21mm)
 Packed by carrying case

LIST PRICE	Qty/Ctn
10375	5

Cordless impact wrench

CIWL1 20 50

Brushless motor
 Voltage: 20V
 Square drive: 1/2"
 No-load speed: 0-1200/0-1800/0-2200rpm
 Impact rate: 0-2400/0-2800/0-3300bpm
 Fastening torque: 500Nm
 Nut-Busting torque: 650Nm
 Integrated LED work light
 Include:
 1 Pcs belt clip
 3 Pcs sockets(21,22,24mm)
 2 Pcs 4.0Ah battery pack(FBLI20021)
 1 Pcs charger(FCLI2001)
 Charge volts:220-240V-50/60Hz

LIST PRICE	Qty/Ctn
13834	5

Cordless impact wrench

CIWL1 20 85

Brushless motor
 Voltage:20V
 Square drive:1/2"
 No-load speed: 0-1600/0-2100/0-2400rpm
 Impact rate: 0-1500/0-1800/0-2200bpm
 Fastening torque:850Nm
 Nut-Busting torque:1000Nm
 Integrated LED work light
 Include:
 3 Pcs deep sockets(22,24,27mm)
 1 Pcs belt clip
 2 Pcs 4.0Ah battery pack(FBLI2002)
 1 Pcs charger(FCLI2001E)
 Charge volts:220-240V-50/60Hz

LIST PRICE	Qty/Ctn
17984	4

Cordless drive ratchet

C DRLI2060151

Voltage: 20V
 Max.torque: 65Nm
 Square Drive: 3/8"
 No-load speed: 250rpm
 Include:
 3 Pcs sockets(13,17,19mm)
 Battery and charger sold separately
 Packed by color box

LIST PRICE	Qty//Cctn
5104 6	8

Battery and charger sold separately



Cordless drive ratchet

CDRLI 20 601 52

Voltage: 20V
 Max.torque: 65Nm
 Square Drive: 3/8"
 No-load speed: 250rpm
 Include:
 3 Pcs sockets(13,17,19mm)
 1 Pcs 2.0Ah battery pack(FBLI2001)
 1 Pcs charge(FCLI2001E)
 Charge volts: 220-240V-50/60Hz
 Packed by carrying case

LIST PRICE	Qty/Ctn
8854	5

Cordless 2 Pcs combo kit

COSLI230702

Voltage:20V
 With 1pcs lithium-ion cordless drill (CDLI200528)
 With 1pcs lithium-ion impact wrench (CIWL12038)
 Lithium-ion cordless drill(CDLI200528):
 No-load speed: 0-400/0-1500rpm
 Max torque: 45Nm
 Plastic chuck
 Chuck capacity: 0.8-10mm
 Torque settings: 15+1
 Mechanical 2-speed gear
 Spindle lock function
 Lithium-ion impact wrench(CIWL12038):

LIST PRICE	Qty/Ctn
12035	4

Cordless angle grinder
CAGLI 21 10 4

Brushless Motor
Voltage:20V
No-load speed:3000/6000/9000rpm
Disc diameter:100mm
Spindle thread:M10
Disc not included
Battery and charger sold separately
Packed by color box



Battery and charger sold separately

LIST PRICE	Qty/Ctn
4399	6

Cordless angle grinder
CAGLI 20 10 08

Brushless Motor
Voltage:20V
No-load speed:3000/8500rpm
Disc diameter:100mm
Spindle thread:M10
Disc not included
Battery and charger sold separately
Packed by color box



Battery and charger sold separately

LIST PRICE	Qty/Ctn
5679	6

Cordless rotary hammer
CRHLI 16 01

Voltage:20V
No-load speed: 0-900rpm
Impact rate: 0-5100bpm
Impact energy: 1.5J
Max.drilling capacity:
Concrete: 16mm
Steel: 10mm
Wood: 20mm
Include:
3 Pcs drills
Battery and charger sold separately
Integrated work light
SDS plus chuck system
Packed by color box



Battery and charger sold separately

LIST PRICE	Qty/Ctn
6789	4

Cordless rotary hammer
CRHLI 20 208

Brushless motor
Voltage: 20V
No-load speed: 0-1100rpm
Impact rate: 0-5400bpm
Impact energy: 2.0J
Max.drilling capacity:
Concrete: 22mm
Steel: 13mm
Wood: 28mm
SDS Plus chuck system
Integrated LED work light
Include:
3 Pcs drill bits(6,8,10mm)
1 Pcs chisel



Battery and charger sold separately

LIST PRICE	Qty/Ctn
6814	4

Cordless rotary hammer
CRHLI 20 228

Brushless motor
Voltage:20V
No-load speed:0-1100rpm
Impact rate:0-5000bpm
Impact energy:2.5J
Max.drilling capacity:
Concrete: 26mm
Steel: 13mm
Wood: 30mm
SDS plus chuck system
Include:
3 Pcs drills
1 Pcs chisel
Battery and charger sold separately



Battery and charger sold separately

LIST PRICE	Qty/Ctn
9243	4

Cordless circular saw
CSLI1851

Brushless motor Voltage: 20V No-load speed: 4800rpm
Blade diameter: 185mm(7-1/4") Arbor size:20mm Cutting capacity: 45° degree: 45mm 90° degree: 65mm Adjustable cutting depth Adjustable bevel cutting Include: 1 Pcs 185mm saw blade Battery and charger sold separately Packed by color box



Battery and charger sold separately

LIST PRICE	Qty/Ctn
8660	4

Cordless circular saw
CSLI18511

Brushless motor
Voltage: 20V
No-load speed: 4800rpm
Blade diameter: 185mm(7-1/4") Arbor size:20mm Cutting capacity: 45° degree: 45mm 90° degree: 65mm Adjustable cutting depth Adjustable bevel cutting Include: 1 Pcs 185mm saw blade 1 Pcs Hex key 1 Pcs 4.0Ah battery pack(FBLI20021)



Battery and charger sold separately

LIST PRICE	Qty/Ctn
12624	4

Ultra-thin TCT saw blade set
TSB1853

2 Pcs/set
Size: 185mm(7-1/4")
Teeth quantity: 24T
Arbor: 20mm
Reduction ring: 16mm
Matrix thickness: 1.0mm
Better for Lithium-ion circular saw
Suitable for lithium-ion circular saw CSLI1851
Wood cutting
Packed by double blister



LIST PRICE	Qty/Ctn
878	50

Cordless jig saw
CJSLI 65 08

Voltage:20V
No-load speed:2400rpm
Cutting capacity:
Wood: 65mm
Metal: 8mm
With 1pcs saw blade
Battery and charger sold separately
Packed by color box



Battery and charger sold separately

LIST PRICE	Qty/Ctn
4993	5

Cordless jig saw
CJSLI 85 01

Voltage:20V
No-load speed:2400rpm
Cutting capacity:
Wood: 80mm
Metal: 8mm
With 5pcs saw blades
Battery and charger sold separately
Packed by color box



Battery and charger sold separately

LIST PRICE	Qty/Ctn
6944	5

Cordless reciprocating saw

CRSLI1152

Voltage:20V
No-load speed:0-2800rpm
Cutting capacity:
Metal:8mm
Wood:115mm

With 1pcs metal saw blade With 1pcs wood saw blade Battery and charger sold separately Packed by color box



Battery and charger sold separately

LIST PRICE	Qty/Ctn
5257	4

Cordless mini chain saw

CGSLI2068

Brushless motor
Voltage:20V
Temperature:300/550°C
Bar length:6"(15cm)
Chain speed:11m/s
Auto lubrication
Include:
1 Pcs 6" saw chain
1 Pcs 6" chain saw bar
1 Pcs wrench
Battery and charger sold separately
Packed by color box



Battery and charger sold separately

LIST PRICE	Qty/Ctn
9684	5

Cordless polisher

AP LI2 00 1

Brushless motor
Voltage:20V
No-load speed:500-2800rpm
Polishing pad diameter:150mm
Spindle thread:M14
Variable speed control
Digital display
Battery and charger sold separately
Packed by color box



Battery and charger sold separately

LIST PRICE	Qty/Ctn
10881	6

Cordless heat gun

HGLI 20 02 5

Voltage:20V
Temperature:300/550°C
Airflow:100/200 L/min
Charge volts:220-240V~50/60Hz
Include:
1 Pcs 4.0Ah Battery pack (FBLI2002)
1 Pcs charger (FCL12001E)
1 Pcs reduction nozzle
1 Pcs reflector nozzle
1 Pcs flat nozzle
Packed by carrying case



LIST PRICE	Qty/Ctn
8272	5

Cordless spray gun

CS GLI 20 03

Voltage: 20V
Spraying pressure: 0.1-0.2Bar
Max.flow: 800ml/min
Max.viscosity: 120DIN-s
Container capacity: 800ml
1 Pcs viscosity measuring cup
1 Pcs nozzle cleaning needle
2 Pcs copper nozzle
Battery and charger sold separately
Packed by color box



Battery and charger sold separately

LIST PRICE	Qty/Ctn
3169	8

Cordless pressure washer

CPWLI2008

Voltage:20V
Max Pressure:24.8Bar
Flow rate:2.2L/min
Auto stop system
Battery and charger sold separately
1 set 6-pattern spray gun
1 pcs 6m water inlet hose with quick connector
1 self suction connector
1 pcs 400ml foam producer
1 pcs portable bag
Packed by color box



Battery and charger sold separately

LIST PRICE	Qty/Ctn
5810	2

Cordless blower

CAB LI 20 018

Voltage:20V
No-load speed:0-9000/0-18000rpm
Max air volume:2.7m³/min
2 speed adjustment
Variable speed trigger
Battery and charger sold separately
Packed by color box



Battery and charger sold separately

LIST PRICE	Qty/Ctn
2765	4

Cordless blower

CAB LI 20 028 1

Voltage: 20V
No-load speed: 18000rpm
Max air volume: 2.7m³/min
Include:
1 Pcs 2.0Ah battery pack(FBLI20011)
1 Pcs charger(FCL12001)
Charge volts: 220-240V~50/60Hz
Packed by color box



LIST PRICE	Qty/Ctn
4669	4

Cordless blower

CAB LI 20 323

Voltage: 20V
No-load speed: 15000rpm
Average air volume:8.5m³/min
Maximum air speed:115km/h
Battery and charger sold separately
Packed by color box



Battery and charger sold separately

LIST PRICE	Qty/Ctn
3498	2

Cordless brad nailer

CBNLI 35 05

Voltage:20V Nail type: F15-F35 Drive rate: 3 nails/s Magazine capacity: 105pcs Include: 1000 Pcs brad nails (35mm) 1pcs air nozzle 1pcs pin Packed by plastic box Suitable for: ANA18201,ANA18251,ANA18301,ANA18351



Battery and charger sold separately

LIST PRICE	Qty/Ctn
11620	6

Cordless grass trimmer

CGTLI20018

Voltage:20V
No-load speed:8200rpm
Cutting diameter:300mm
Line dia:1.6mm twisted
Line length:5m
Edging function
Battery and charger sold separately
Packed by color box

LIST PRICE Qty/Ctn
4384 2

Cordless grass trimmer

CGTLI20301

Voltage:20V
No-load speed:8200rpm
Cutting diameter:300mm
Line dia:1.6mm twisted
Line length:5m
Edging function
Include:
1 Pcs safety goggles
1 Pcs PU Coated Gloves
1 Pcs 2.0Ah battery pack(FBLI2001)
1 Pcs charger(FCLI2001E)
Charge volts: 220-240V-50/60Hz
Packed by color box

LIST PRICE Qty/Ctn
6917 2

Cordless hedge trimmer

CHTLI20461

Voltage:20V
Maximum speed :2800spm
Blade cutting length:460mm
Maximum cutting diameter:18mm
Laser cut blade
Include:
1 Pcs safety goggles
1 Pcs PU coated gloves
1 Pcs 2.0Ah battery pack(FBLI2001)
1 Pcs charger(FCLI2001E)
Charge volts: 220-240V-50/60Hz
Packed by color box

LIST PRICE Qty/Ctn
8162 2

Cordless gauge straight shear

CSSLI20258

Brushless Motor
Voltage:20V
Cutting diameter:25mm
Include:
1 Pcs oil bottle(empty)
1 Pcs sharpening stone
1 Pcs sheath
Battery and charger sold separately
Packed by Color box

LIST PRICE Qty/Ctn
8245 6

Hea dlam p

HHL013AAA5

Brightness:100 lumens
Use alkaline 3AAA battery
Max 91m beam distance
IPX4 raining resistant
Packed by color box

LIST PRICE Qty/Ctn
420 24

Cordless work lamp

CWLI2023

Voltage:20V
LED power dissipation:1.5W
Lumens:150±10%
Battery and charger sold separately
Packed by double blister

LIST PRICE Qty/Ctn
836 12

Cordless portable lamp

CWLI2025

Voltage:20V
LED power dissipation:20W
Lumens:
High:1800
Low:900
Battery and charger sold separately
Packed by color box

LIST PRICE Qty/Ctn
3055 6

Cordless vacuum cleaner

CVLI201261

Voltage:20V
Dust Capacity:0.5L
Vacuum Pressure:≥9kpa
With 1 pcs crevice nozzle
With 1 pcs dust brush
Packed by color box

LIST PRICE Qty/Ctn
2404 8

Lithium-Ion battery pack

FBL I20 01 1

Voltage:20V
Lithium-ion 2.0Ah battery
LED battery power indicator
One battery fits all P20S multiple tools
Packed by color box

LIST PRICE Qty/Ctn
2235 20

Lithium-Ion battery pack

FBL I20 02

Voltage:20V
Lithium-ion 4.0Ah battery
LED battery power indicator
One battery fits all P20S multiple tools
Packed by color box

LIST PRICE Qty/Ctn
4131 12

Lithium-Ion battery pack
FBLI2003

Voltage:20V
Lithium-ion 5.0Ah battery
LED battery power indicator
One battery fits all P20S multiple tools
Packed by color box



LIST PRICE	Qty/Ctn
5976	12

P20S battery charger
FCLI2001

Input voltage:220-240V~50/60Hz
Output voltage:20V
Output current:2A
Packed by color box



LIST PRICE	Qty/Ctn
1188	20

P20S Lithium-Ion battery and charger kit
FBCPK1222

Voltage: 20V
With 2pcs lithium-ion battery pack(FBLI20011)
With 1 pcs charger(FCLI2001)
Lithium-ion battery pack(FBLI20011):
Lithium-ion 2.0Ah battery
LED battery power indicator
One battery fits all P20S multiple tools
Fast intelligent charger(FCLI2001):
Input voltage:220-240V~50/60Hz
Output voltage:20V
Output current:2A
Packed by double blister



LIST PRICE	Qty/Ctn
5260	10

Cordless glue gun
CGG LI2 00 1

Voltage:20V
Gluing capacity:15-18g/min
Glue stick diameter:11.2mm
Heat-up time: 60s
With 3 pcs 150mm glue sticks
Battery and charger sold separately
Packed by double blister



LIST PRICE	Qty/Ctn
1553	36

Cordless tile vibration machine
CTVLI2010

Voltage:20V
Vibrational frequency:0-10000rpm
Adsorbability:50kg
Battery and charger sold separately
Packed by color box



LIST PRICE	Qty/Ctn
3813	10

Cordless hydraulic crimping tool
CTL I20 02

Drill voltage: 20V
crimping range:16-400mm²
Crimping force:120KN
Crimp cycle:6-18s(depend on the size of cable)
Stroke:42mm
2pcs 20V Cordless 4.0Ah batteries
LED usage count display
ACCESSORIES:
Crimping dies:16,25,35,50,70,95,120,150,185,240,300,400mm²
With 2pcs battery pack(FBLI2002)
With 1pcs 2Hr charger(FCLI2001E)



LIST PRICE	Qty/Ctn
125810	1

Cordless hydraulic cable cutter
CRCLI 20 02

Drill voltage: 20V
Max cutting diameter:85mm
Cutting force:60KN
Stroke:86mm
2pcs 20V Cordless 4.0Ah batteries
LED usage count display
Charge volts:220V-240V~50/60Hz
ACCESSORIES:
With 1 pcs blade
With 2pcs battery pack(FBLI2002)
With 1 pcs 2Hr charger(FCLI2001E)
With 1 set Sealing ring of cylinder
With 1 set Sealing ring of safety with 1 set valve
With 1 set hydraulic fluid



LIST PRICE	Qty/Ctn
125810	1

Electric drill
ED50028

Voltage:220-240V~50/60Hz
Input power:500W
No-load speed:0-3300rpm
Max.drilling capacity:10mm
Variable speed control
Forward/Reverse switch
With 1 set extra carbon brushes
Packed by color box



LIST PRICE	Qty/Ctn
2352	5

Electric drill
ED500 28 2

Voltage:220-240V~50/60Hz
Input power:500W
No-load speed:0-3300rpm
Max.drilling capacity: 10mm
10mm keyless chuck
Variable speed control
Forward/Reverse switch
With 1 set extra carbon brushes
Packed by color box



LIST PRICE	Qty/Ctn
2352	5

Impact drill
ID6808

Voltage:220-240V~50/60Hz
Input power:680W
No-load speed:0-3000rpm
Max.drilling capacity:13mm
Variable speed control
Forward/Reverse switch
Hammer function
Packed by color box



LIST PRICE	Qty/Ctn
2430	10

Impact drill

ID7108

710W 13mm

Voltage: 220-240V~50/60Hz
 Input power: 710W
 No-load speed: 0-3000rpm
 Max.drilling capacity: 13mm
 Variable speed control
 Forward/Reverse switch
 Hammer function
 Packed by color box



LIST PRICE	Qty/Ctn
2968	10

Impact drill

ID211008

1100W 16mm

Voltage: 220-240V~50/60Hz
 Input power: 1100W
 No-load speed: 0-1200rpm/0-3000rpm
 Max.drilling capacity: 16mm
 Variable speed control
 Forward/Reverse action
 Hammer function
 Aluminum 2 mechanical gear box
 With 1 set extra carbon brushes
 Packed by color box



LIST PRICE	Qty/Ctn
7442	5

115 Pcs tools set

HKTHP11151

115 Pcs Tools Set 1 Pcs 680W Impact Drill (ID6808) 220-240V~50/60Hz, 13mm key chuck

Include:

- 1 Pcs 8Oz Claw Hammer
- 1 Pcs 7" Combination Pliers
- 1 Pcs 6" Adjustable Wrench
- 1 Pcs SL5.5x100 Screwdriver
- 1 Pcs PH1x100 Screwdriver
- 1 Pcs 3M Steel measuring tape
- 4 Pcs Wood Drill bits 4,5,6,8mm
- 5 Pcs Twist Drill bits 2,3,4,5,6mm
- 5 Pcs Masonry Drill bits 4,5,6,8,10mm
- 1 Pcs 9mm Snap-off blade knife



LIST PRICE	Qty/Ctn
5392	4

Mixer

MX11008

1100W 16mm

Voltage: 220-240V~50/60Hz
 Input power: 1100W
 No-load speed: 0-680rpm
 Max.drilling capacity: 16mm
 Forward/Reverse action
 Aluminum gear box
 With 1 pcs mixing pad
 With 1 set extra carbon brushes
 Packed by color box



LIST PRICE	Qty/Ctn
6363	4

Mixer

MX214008

1400W

Voltage: 220-240V~50/60Hz
 Input power: 1400W
 No-load speed: 0-500rpm/0-750rpm
 Mixing pad thread: M14
 Aluminum gear box
 Integrated work light
 With 1 pcs mixing pad
 With 1 set extra carbon brushes
 Packed by color box



LIST PRICE	Qty/Ctn
9130	2

Mixer

MX218008

1800W

Voltage: 220-240V~50/60Hz
 Input power: 1800W
 No-load speed: 180-480rpm/250-680rpm
 Mixing pad thread: Hex13
 Aluminum gear box
 Twin paddles with quick fix system
 With 2 pcs mixing pads
 With 1 set extra carbon brushes
 Packed by color box



LIST PRICE	Qty/Ctn
14186	2

Impact wrench

IW10508

1050W 550N.m

Voltage: 220-240V~50/60Hz
 Input power: 1050W
 No-load speed: 2300rpm
 Max torque: 550NM
 Square drive: 1/2"
 Aluminum gear box with rubber
 With 6 pcs sockets (17,18,19,21,23,24mm)
 With 1 pcs 125mm adaptor
 With 1 set extra carbon brushes
 Packed by BMC



LIST PRICE	Qty/Ctn
9684	2

Angle grinder

AG71 18 2

710W Ø100mm(4")

Voltage: 220-240V~50/60Hz
 Input power: 710W
 No-load speed: 12000rpm
 Disc diameter: 100mm
 Spindle thread: M10
 With 1 pcs auxiliary handle
 Disc not included
 Packed by color box



LIST PRICE	Qty/Ctn
2739	10

Angle grinder

AG75 02 82

750W Ø100mm(4")

Voltage: 220-240V~50/60Hz
 Input power: 750W
 No-load speed: 12000rpm
 Disc diameter: 100mm
 Spindle thread: M10
 With 1 pcs auxiliary handle
 Disc not included
 Packed by color box



LIST PRICE	Qty/Ctn
2892	10

Angle grinder

AG90 02 82

900W Ø100mm(4")

Voltage: 220-240V~50/60Hz
 Input power: 900W
 No-load speed: 12000rpm
 Disc diameter: 100mm
 Spindle thread: M10
 With 1 pcs auxiliary handle
 Disc not included
 Packed by color box



LIST PRICE	Qty/Ctn
3144	6

Angle grinder

AG90028

Voltage:220-240V~50/60Hz
 Input power:900W
 No-load speed:12000rpm
 Disc diameter:125mm
 Spindle thread:M14
 With 1pcs auxiliary handle
 Disc not included
 Packed by color box



900W Ø125mm(5")

125mm(5")

LIST PRICE	Qty/Ctn
3333	6

Angle grinder

AG90028S

Voltage:220-240V~50/60Hz
 Input power:900W
 No-load speed:5000-12000rpm
 Disc diameter:125mm
 Spindle thread:M14
 With 1pcs auxiliary handle
 Variable speed control
 Disc not included
 Packed by color box



900W Ø125mm(5")

125mm(5")

Variable Speed

LIST PRICE	Qty/Ctn
3916	6

Angle grinder

AG11 00 38

Voltage: 220-240V~50/60Hz
 Input power: 1100W
 No-load speed: 12000rpm
 Disc diameter: 125mm
 Spindle thread: M14
 With 1pcs auxiliary handle
 Disc not included
 Packed by color box



1100W Ø125mm(5")

125mm(5")

LIST PRICE	Qty/Ctn
4014	6

Angle grinder

AG20 00 18

Voltage:220-240V~50/60Hz
 Input power:2000W
 No-load speed:8450rpm
 Disc diameter:180mm
 Spindle thread:M14
 With 1pcs auxiliary handle
 With 1set extra carbon brushes
 Disc not included
 Packed by color box



2000W Ø180mm(7")

180mm(7")

LIST PRICE	Qty/Ctn
7621	2

Straight grinder

SG11 00 8

Voltage: 220-240V~50/60Hz
 Input power: 1100W
 No-load speed: 5000rpm
 Disc diameter: 150mm
 Spindle thread: M14
 Include:
 1set extra carbon brushes
 1 Pair Gloves
 Packed by color box



1100W Ø150mm

LIST PRICE	Qty/Ctn
8926	2

Polisher

AP140016

Voltage:220-240V~50/60Hz Input power:1400W No-load speed:1500-3600rpm Polishing pad diameter:180mm Spindle Type : M14 Variable speed control Lock-on switch Aluminum gear box With 1pcs D-handle With 1pcs hook&loop polishing pad With 1pcs polishing bonnet With 1set extra carbon brushes Packed by color box



1400W

Variable speed

LIST PRICE	Qty/Ctn
7289	4



LIST PRICE Qty/Ctn
0

LIST PRICE Qty/Ctn
0

LIST PRICE Qty/Ctn
0

LIST PRICE Qty/Ctn
0

Reciprocating saw
RS8008

Voltage:220-240V~50/60Hz
Rated power:750W
No-load speed:900-3300rpm
Max.cutting depth:

Wood:115mm
Steel:8mm
Aluminum:12mm
SDS blade change chuck With 1pcs metal saw blade With 1pcs wood saw blade With 1pcs hex key With 1set extra carbon brushes Packed by color box



LIST PRICE	Qty/Ctn
6630	4

Reciprocating saw
RS12001

Voltage:220-240V~50/60Hz
Input power: 1200W
No-load speed:1000~2800rpm
Max.cutting depth:
Wood:210mm
Steel:20mm
Aluminum:10mm
Variable speed control
Integrated work light 4 step pendulum function SDS blade change chuck With 1pcs metal saw blade With 1set extra carbon brushes



LIST PRICE	Qty/Ctn
9711	4

Rotary hammer
RGH6 528

Voltage:220-240V~50/60Hz
Input power:650W
No-load speed:0-1700rpm
Impact rate:0-5500bpm
Impact energy:1.7J
Max.drilling capacity:

Concrete:22mm
Steel:10mm
Wood:25mm
SDS plus chuck system With 3 SDS-PLUS drills With 1set extra carbon brushes Packed by BMC



LIST PRICE	Qty/Ctn
5156	4

Rotary hammer
RGH9 028

Voltage:220-240V~50/60Hz
Input power:800W
No-load speed:0-1100rpm
Impact rate:0-4000bpm
Impact energy:2.5J
Max.drilling capacity:

Concrete:26mm
Steel:13mm
Wood:30mm
SDS plus chuck system With 3 drills and 2 chisels With 1set extra carbon brushes Packed by BMC



LIST PRICE	Qty/Ctn
6285	4

Rotary hammer
RGH9 528

Voltage:220-240V~50/60Hz
Input power:950W
No-load speed:0-1050rpm
Impact rate:0-4670bpm
Impact energy:2.5J
Max.drilling capacity:

Concrete:28mm
Steel:13mm
Wood:30mm
SDS plus chuck system With 3 drills and 2 chisels With 1set extra carbon brushes Packed by BMC



LIST PRICE	Qty/Ctn
8267	4

Rotary hammer
RH10 506

Voltage:220-240V~50/60Hz
Input power:1050W
No-load speed:1100rpm
Impact rate:3800bpm
Impact energy:4.5J
Max.drilling capacity:

Concrete:26mm
Steel:13mm
Wood:40mm
SDS plus chuck system With 3 drills and 2 chisels Packed by BMC



LIST PRICE	Qty/Ctn
7264	2

Rotary hammer
RH15 002 8

Voltage:220-240V~50/60Hz
Input power:1500W
No-load speed:850rpm
Impact rate:4400bpm
Impact energy:5.5J
Max.drilling capacity:

Concrete:32mm
Steel:13mm
Wood:40mm
SDS plus chuck system
Anti-vibration system
With 3 drills and 2 chisels
With 1set extra carbon brushes
Packed by BMC



LIST PRICE	Qty/Ctn
8979	2

Rotary hammer
RH15 003 8

Voltage:220-240V~50/60Hz
Input power:1500W
No-load speed:950rpm
Impact rate:4500bpm
Impact energy:5.5J
Max.drilling capacity:

Concrete:32mm
Steel:13mm
Wood:40mm
SDS plus chuck system
Anti-vibration system
With 3 drills and 2 chisels
Packed by BMC



LIST PRICE	Qty/Ctn
8992	2

Rotary hammer
RH16 008

Voltage:220-240V~50/60Hz
Input power:1600W
No-load speed:550rpm
Impact rate:3850bpm
Impact energy:9.0J
Max.drilling capacity:

Concrete:38mm
Core bit:100mm
SDS MAX chuck system
Chisel-locking system
Anti-vibration system
With 2 drills and 2 chisels
With 1set extra carbon brushes
Packed by BMC



LIST PRICE	Qty/Ctn
15768	2

Demolition breaker
PDB130018

Voltage:220-240V~50/60Hz
Input power:1300W
Impact rate:3800bpm
Impact force:20J
Anti-vibration system
HEX chuck system
7Kgs demolition breaker
With 2pcs chisels
With 1set extra carbon brushes
Packed by BMC



LIST PRICE	Qty/Ctn
11884	2

Demolition breaker
PDB15006

Voltage:220-240V~50/60Hz
 Input power:1500W
 Impact rate:1000-1900bpm
 Impact force:6-25J
 Anti-vibration system
 Auto-stop carbon brushes
 Constant electronics power
 Chisel-locking system
 SDS-MAX chuck system
 10Kgs demolition breaker
 With 2pcs chisels
 With 1set extra carbon brushes
 Packed by BMC

1500W 10.5kg(22lbs)

LIST PRICE	Qty/Ctn
24146	1

Demolition breaker
PDB17008

Voltage:220-240V~50/60Hz
 Input power:1700W
 Impact rate:1400bpm
 Impact force:45J
 HEX chuck system
 16Kgs demolition breaker
 With 2pcs chisels
 With 1set extra carbon brushes
 Packed by BMC

1700W 16kg(35.2lbs)

LIST PRICE	Qty/Ctn
20373	1

Demolition breaker
PDB22 001

Voltage:220-240V~50/60Hz
 Input power:2200W
 Impact rate:950bpm
 Impact energy:75J
 Anti-vibration system
 Auto-stop carbon brushes
 HEX chuck system
 30Kgs demolition breaker
 4m rubber cable
 With 2pcs chisels
 With 1set extra carbon brushes
 Packed by carton box

2200W 30kg(66lbs)

LIST PRICE	Qty/Ctn
58378	1

Circular saw
CS18578

Voltage:220-240V~50/60Hz
 Input power:1200W
 No-load speed:5000rpm
 Blade diameter:185x20mm
 Cutting capacity:
 45 degree:45mm
 90 degree:65mm
 Adjustable cutting depth
 Adjustable bevel cutting
 With 1pcs 185mm blade
 Packed by color box

1200W 185mm(7-1/4")

LIST PRICE	Qty/Ctn
5346	2

Multi function saw
MFS1251

Voltage:220-240V~50/60Hz
 Input power:750W
 No-load speed:4700rpm
 Cutting capacity:
 45 degree:31mm
 90 degree:47mm
 With 1pcs 125x22.2mm TCT blade
 With 1pcs 125x22.2mm diamond cutting disc
 With 1set extra carbon brushes
 Packed by color box

750W Ø125mm

LIST PRICE	Qty/Ctn
9482	4

Circular saw
CS18538

Voltage: 220-240V~50/60Hz
 Input Power:1400W
 No-load speed:4800rpm
 Blade diameter:185x20mm
 Cutting capacity:
 45 degree:45mm
 90 degree:65mm
 Adjustable cutting depth
 Adjustable bevel cutting
 With 1pcs 185mm blade
 With 1set extra carbon brushes
 Packed by color box

1400W 185mm(7-1/4")

LIST PRICE	Qty/Ctn
6162	2

Jig saw
JS400285

Voltage: 220-240V~50/60Hz
 Input power: 400W
 No-load speed: 800-3000rpm
 Cutting capacity:
 Wood: 55mm
 Steel: 3mm
 Variable speed control
 With 1pcs saw blade
 Packed by color box



LIST PRICE	Qty/Ctn
3043	10

Jig saw
JS57028

Voltage: 220-240V~50/60Hz
 Input power: 570W
 No-load speed: 800-3000rpm
 Cutting capacity:
 Wood: 65mm
 Steel: 8mm
 Variable speed control
 4 step pendulum function
 Include:
 3 Pcs saw blades
 1 Set extra carbon brushes
 Packed by color box



LIST PRICE	Qty/Ctn
3458	5

Jig saw
JS80028

Voltage:220-240V~50/60Hz
 Input power:800W
 No-load speed:800-3000rpm
 Cutting capacity:
 Wood:100mm
 Steel:10mm
 Variable speed control
 4 step pendulum function
 Aluminum base
 With 5pcs saw blades
 With 1set extra carbon brushes
 Packed by color box



LIST PRICE	Qty/Ctn
5423	5

Palm sander
PS2416

Voltage: 220-240V~50/60Hz
 Input power: 240W
 No-load speed: 14000rpm
 Bottom base: 110mmx100mm
 Include:
 5 Pcs sand papers (AKFS140102)
 1 Set extra carbon brushes
 Packed by color box

240W 110x100mm

LIST PRICE	Qty/Ctn
3292	10

Finishing sander
FS3208

Voltage:220-240V~50/60Hz
 Input power:320W
 No-load speed:14000rpm
 Bottom base:90mmx180mm
 Aluminum durable base
 With 5pcs sand papers(AKFS240101-1)
 With 1set extra carbon brushes
 Packed by color box



LIST PRICE	Qty/Ctn
4014	6

Rotary sander
RS3208

Voltage:220-240V~50/60Hz
 Input power:320W
 No-load speed:12000rpm
 Dia of sanding pad:125mm
 Velcrops base
 With 5pcs sand papers(AKRS125051)
 With 1set extra carbon brushes
 Packed by color box



LIST PRICE	Qty/Ctn
4464	8

Rotary sander
RS4508

Voltage:220-240V~50/60Hz
 Input power:450W
 No-load speed:4000-13000rpm
 Dia of sanding pad:150mm
 Velcrops base
 Variable speed control
 With 5pcs sand papers
 With 1set extra carbon brushes
 Packed by color box



LIST PRICE	Qty/Ctn
5357	6

Drywall sander
DWS10501

Voltage:220-240V~50/60Hz
 Input power:1050W
 No-load speed:600-2600rpm
 Grinding pad diameter:215mm
 Sanding paper diameter:225mm
 Tube diameter:32mm
 Dust hose diameter:38mm
 Integrated work light
 With 12pcs sand papers
 With 3pcs connection adapters
 With 2m flexible pipe
 With 1pcs extension bar
 With 1pcs dust bag
 With 1set extra carbon brushes



LIST PRICE	Qty/Ctn
13061	2

Electric planer
PL5508

Voltage: 220-240V~50/60Hz
 Input power: 550W
 No-load speed: 16000rpm
 Planning width&depth: 82x1mm
 Heavy duty aluminum base
 Aluminum side cover
 Include: 1 Pcs socket wrench
 1 Pcs parallel guide
 Packed by color box



LIST PRICE	Qty/Ctn
4120	4

Electric planer
PL7508

Voltage:220-240V~50/60Hz
 Input power:750W
 No-load speed:17000rpm
 Planning width&depth:82x2mm
 Heavy duty aluminum base
 Aluminum side cover
 With 1 pcs socket wrench
 With 1 pcs parallel guide
 With 1 set extra carbon brushes
 Packed by color box



LIST PRICE	Qty/Ctn
6208	4

Belt sander
PBS12001

Voltage:220-240V~50/60Hz
 Input power:1200W
 No-load speed:500rpm
 Sanding belt size: 610x100mm
 Quick release belt change system
 Dust suction facility
 Aluminum housing base
 With 1pcs sanding belt
 With 1set extra carbon brushes
 Packed by color box



LIST PRICE	Qty/Ctn
12755	2

Thickness planer
TP15003

Voltage:220-240V~50/60Hz
 Input power:1500W
 No-load speed:9000rpm
 Max cutting length:127mm
 Max cutting width:318mm
 Max cutting depth:2.5mm
 Cutting thickness:5-153mm
 Feeding speed:8m/min
 Packed by carton box



LIST PRICE	Qty/Ctn
37627	1

Jointer and planer
JAP15001

Voltage:220-240V~50/60Hz
 Input power:1500W
 Blade speed:9000rpm
 Blade size:210mmx16.5mm
 Max cutting width:204mm
 Jointer table size:740mmx212mm
 Planer table size:270mmx204mm
 Range of cutting depth:5-120mm
 Feeding speed:6m/min
 Packed by carton box



LIST PRICE	Qty/Ctn
27114	1

Scroll saw
SS852

Voltage:220-240V~50Hz
 Input power:85W
 No-load speed:1450rpm
 Blade size:133mmx2.6mmx0.25mm(18TPI)
 Max cutting depth:50mm
 Max cutting width:410mm
 Table size:375mmx250mm
 Table tilting range:0-45°
 Steel table tilts 45°left and right
 Packed by carbon box



LIST PRICE	Qty/Ctn
10209	1

Band saw
BAS3502

Voltage:220-240V-50Hz
 Input power:350W
 Max.cutting depth:80mm
 Max.cutting width:230mm
 Table size:300mmx300mm
 Table tilting range:0°-45°
 Blade length:1575mm
 Blade width:6.35mm
 Blade teeth:6TPI
 Blade thickness:0.3mm
 Packed by carton box



LIST PRICE	Qty/Ctn
21920	1

Electric router
RT160028

Voltage:220-240V-50/60Hz
 Input power:1600W
 No-load speed:22000rpm
 Collet size:6mm,8mm,12mm,1/4",1/2"
 Plunge capacity:0-60mm
 With 1pcs guide holder
 With 1pcs template guide
 With 1pcs trimmer guide
 With 1pcs straight guide
 With 1 set extra carbon brushes
 Packed by color box

1600W

LIST PRICE	Qty/Ctn
8056	2

Laminate trimmer
PLM5002

Voltage:220-240V-50/60Hz
 Input power:500W
 No-load speed:33500rpm
 Chuck diameter:6mm and 1/4"
 With 1pcs template guide
 With 1set trimmer guide
 With 1set straight guide
 With 1set extra carbon brushes
 Packed by color box



LIST PRICE	Qty/Ctn
4603	6

Laminate trimmer
PLM6001

Voltage:220-240V-50/60Hz
 Input power:600W
 No-load speed: 34500rpm
 Collet size: 6mm and 1/4"
 Include:
 2Pcs wrenches
 1Pcs template guide
 1Pcs horizontal guide rail
 1Pcs linear guide
 1Set roller components
 1Set extra carbon brushes
 Packed by color box



LIST PRICE	Qty/Ctn
5312	6

Mini grinder
M G133 28

Voltage:220-240V-50/60Hz
 Input power:130W
 No-load speed:10000-35000rpm
 Collet size:3.2mm/2.3mm
 Variable speed control
 With 1pcs flexible shaft
 With 109pcs accessories
 With 1set extra carbon brushes
 Packed by BMC



LIST PRICE	Qty/Ctn
2694	5

Accessories for mini grinder
Mini grinder
M G200 8

Voltage:220V-240V-50/60Hz
 Input power:200W
 No-load speed:10000-40000rpm
 Collet size:3.2mm/2.3mm
 LCD display
 Variable speed control
 With 1pcs flexible shaft
 With 149pcs accessories
 With 1pcs safe guard
 With 1pcs cutting guide
 With 1set extra carbon brushes
 Packed by BMC



LIST PRICE	Qty/Ctn
3846	5

Die grinder
AKB1012

Accessories for mini grinder, 3mm shank,suitable for MG13328 MG2008 CMGL2001
 2 Pcs bullet type 10*18mm
 4 Pcs cone 13*21mm
 2 Pcs T-type 12*13mm
 2 Pcs round 12*12mm
 Packed by double blister and color box



LIST PRICE	Qty/Ctn
148	200

Accessories for die grinder
PDG5501

Voltage:220-240V-50/60Hz
 Input power:550W
 No-load speed:29000rpm
 Collet size:6mm
 Aluminum gear housing
 With 1set extra carbon brushes
 With 3pcs mounted points
 Packed by color box



LIST PRICE	Qty/Ctn
4834	10

Tungsten carbide rotary burrs set
AKB0502

Suitable for Die grinder PDG5501,6mm shank
 1 Pcs cylindrical 19*26mm
 1 Pcs bullet type 14*25mm
 1 Pcs cone 25*38mm
 1 Pcs T-type 25*13mm
 1 Pcs round 23*24mm
 Packed by double blister and color box



LIST PRICE	Qty/Ctn
149	100

HRRC0051

Tungsten carbide rotary burrs set
 5Pcs/set (cylindrical shape,tree shape,cylindrical shape,ball shape,flame shape)
 Material:Tungsten Carbide
 Double Cut
 Shank:6mm
 Head size:8mm
 Carbide Burs are used for shaping, grinding and for the removal of sharp edges, burrs and excess material (deburring)
 Used on pneumatic or electric die grinders
 Packed by plastic box



LIST PRICE	Qty/Ctn
2958	60

Multi-function tools
MF3008

Voltage:220-240V~50/60Hz
 Input power:300W
 No-load speed:10000-20000rpm
 With 1pcs flexibel scraper blade
 With 1pcs cutting saw blade
 With 1pcs segment saw blade
 With 1pcs delta sand pad
 With 3pcs sand papers
 Pack by color box



LIST PRICE	Qty/Ctn
3645	8

Multi tool blade set
AKTMT1502

15pcs/set
 Suitable for CML12001, MF3008 and UMF3008,
 1pcs BIM(M2) Segment saw blade, Dia.87mm(3-7/16")
 1pcs Delta sanding Pad, size:80mm(3-1/8")
 10pcs Aluminum-Oxide delta sandpaper for Wood, size:80mm(3-1/8")
 1pcs CRV Radial flush-cut wood saw blade, size:34mm(1-5/16")
 1pcs Bi-Metal standard flush-cut metal sawblade, size:34mm(1-5/16")
 1pcs Rigid scraper, size:50mm(2")
 Packed by double blister



LIST PRICE	Qty/Ctn
989	40

Marble cutter
M C140 08

Voltage:220-240V~50/60Hz
 Input power:1400W
 No-load speed:1300rpm
 Diameter of blade:110x20mm
 Max.cutting capacity:34mm
 Adjustable cutting depth
 Include 1pcs dry diamond disc
 Packed by color box



LIST PRICE	Qty/Ctn
4912	4

Dry diamond disc
DM D011 10 2

110(4 3/8")X20mm
 Blade width:10mm
 Packed by color box



LIST PRICE	Qty/Ctn
195	100

Wall chaser
WLC15008

Voltage:220-240V~50/60Hz
 Input power:1500W
 No-load speed:10500rpm
 Disc diameter:125mm
 Spindle thread:M14
 Cutting depth:3-29 mm
 Cutting width:8-30 mm
 With 1pcs chisel
 With 1pcs auxiliary handle
 With 1set extra carbon brushes
 With 4pcs cutting discs
 Packed by color box



LIST PRICE	Qty/Ctn
13557	2

Dry diamond disc
DM D011 25 4

125(5")X22.2mm
 Blade width:7.5mm
 Match with WLC15008 & UWLC15008
 Packed by double blister



LIST PRICE	Qty/Ctn
387	100

Wall chaser
WLC30001

Voltage:220-240V~50/60Hz
 Input power:3000W
 No-load speed: 6500rpm
 Disc diameter: 130mm
 Spindle thread: M20
 Cutting depth : 9-30mm
 Cutting width : 10-40mm
 With 1pcs auxiliary handle
 With 1set carbon brushes
 With 5pcs cutting discs
 With 1pcs socket wrench
 With 1pcs wrench
 With 1pcs hex key
 With 1pcs water pump



LIST PRICE	Qty/Ctn
24377	1

Dry diamond disc
DM D011 30 1

130(5")X20mm
 Blade width:12mm
 Metal base thickness:1.6mm
 Universal
 Match with WLC30001
 High concentration diamond
 Packed by double blister



LIST PRICE	Qty/Ctn
560	100

Power cutter
PC3558

Voltage:220-240V~50/60Hz
 Input power:2800W
 Blade size:355mmx25.4mm
 No-load speed:4800rpm
 Max.cutting depth:120mm
 With 1set extra carbon brushes
 With 1pcs 355mm cutting disc
 With 1pcs 5m water pipe
 Packed by carton box



LIST PRICE	Qty/Ctn
34282	1

Diamond disc for asphalt and concrete cutting
DM D033 55 1

355mm(14")X25.4mm
 Blade width:12mm
 Suitable for item PC3558
 Packed by color box



LIST PRICE	Qty/Ctn
2768	10

Diamond drilling machine

DDM28001

Voltage:220-240V~50/60Hz
 Input power:2800W
 No-load speed:800rpm
 Max. drilling diameter:200mm
 Spindle thread:M22
 With drilling stand
 With 1 set carbon brushes
 With leakage protection switch
 Packed by carton box

2800W **Ø200mm**



Spindle thread:
M22

LIST PRICE	Qty/Ctn
25806	1

Aspirator blower

AB 40 38

Voltage: 220-240V~50/60Hz
 Input power: 400W
 No-load speed: 14000rpm
 Max. blowing rate: 3.2m³/min
 Cable length: 2m
 Include:
 1Pcs dust bag
 Packed by color box

400W

1.2m³/min



LIST PRICE	Qty/Ctn
2117	4

Aspirator blower

AB 60 08

Voltage:220-240V~50/60Hz
 Input power:600W
 No-load speed:0-16000rpm
 Blowing rate:0-3.5m³/min
 Variable speed control
 With 1pcs dust bag
 Packed by color box

600W

0-3.5m³/min



LIST PRICE	Qty/Ctn
3678	4

Aspirator blower

AB 60 38

Voltage: 220-240V~50/60Hz
 Input power: 650W
 No-load speed: 0-16000rpm
 Blowing rate: 0-4.0m³/min
 Variable speed control
 Cable length: 2m
 Include:
 1Pcs dust bag
 Packed by color box

650W

0-4.0m³/min



Variable Speed

LIST PRICE	Qty/Ctn
2739	4

Aspirator blower

AB 80 08

Voltage:220-240V~50/60Hz
 Input power:800W
 No-load speed:0-15000rpm
 Blowing rate:0-4.5m³/min
 Variable speed control
 With 1pcs dust bag
 With 1pcs flexible tube
 With 2pcs suction nozzles
 With 1set extra carbon brushes
 Packed by color box

800W

0-4.5m³/min



Variable Speed

LIST PRICE	Qty/Ctn
5820	4

Spray gun

SPG3508

Voltage:220-240V~50/60Hz
 Input power:450W
 Spraying Pressure:0.1-0.2Bar
 Max. flow:380ml/min
 Max. viscosity:50DIN-s
 Container capacity:800ml
 With 1pcs viscosity measuring cup
 With 1pcs nozzle cleaning needle
 Packed by color box

450W



LIST PRICE	Qty/Ctn
2616	8

HVLP spray gun

SPG5008

Voltage:220-240V~50/60Hz
 Input power:550W
 Spraying Pressure:0.1-0.2Bar
 Max. flow:850ml/min
 Max. viscosity:50DIN-s
 Container capacity:800ml
 Power cord length:2.0m
 With 1pcs viscosity measuring cup
 With 1pcs nozzle cleaning needle
 With 1pcs shoulder strap
 Packed by color box

550W



LIST PRICE	Qty/Ctn
3514	4

Heat gun

HG20 00 78

Voltage: 220-240V~50/60Hz
 Input power: 2000W
 Temperature:50/450°C/550°C
 Airflow:450/300/450 L/min
 3 temperature settings
 Include:
 1 Pcs reduction nozzle
 1 Pcs reflector nozzle
 1 Pcs flat nozzle
 1 Pcs scraper
 Packed by color box

2000W



LIST PRICE	Qty/Ctn
1909	10

Glue gun

GG1 48

Volts:220-240V~50/60Hz
 Input power:20W(100W)
 Gluing capacity:15-22g/min
 Glue stick diameter:11.2mm
 With 2 pcs 150mm glue sticks
 Packed by double blister

20W(Max.100W)



Ø11mm x 2PCS

LIST PRICE	Qty/Ctn
621	36

Electric soldering iron

SI016 83 1

Voltage:220-240V~50/60Hz
 Input power:60W
 Preheat.time:1~2minutes
 Straight, tip head
 Temperature can be adjusted by rotating
 Built-in ceramic heating element for fast and stable heating, easy to replace
 With a piece of stand
 Long life replaceable tip
 Packed by sliding card

60W

Long life eye

Temperature can be adjusted by rotating



Long life

LIST PRICE	Qty/Ctn
510	50

Soldering gun with solder feeder
SI016732

Voltage:220-240V-50/60Hz
 Input power:90W
 Preheat time:20 seconds
 Straight, tip head
 with Solder Wire Feeder
 Temperature can be adjusted by rotating and thermostatic
 Built-in ceramic heating element for fast and stable heating, easy to replace
 Long life replaceable tip
 Packed by sliding card



LIST PRICE	Qty/Ctn
1173	48

Soldering station
SI016923

Voltage:220-240V-50/60Hz
 Input power:60W
 Preheat time:1minutes
 Straight, tip head
 Digital display
 Temperature can be adjusted by rotating and thermostatic
 Built-in ceramic heating element for fast and stable heating, easy to replace
 With a piece of stand
 Long life replaceable tip
 Packed by color box



LIST PRICE	Qty/Ctn
4688	12

Cut off saw
COS223558

Voltage: 220-240V-50/60Hz
 Input power: 2200W
 No-load speed: 3700rpm
 Blade size: 355mmx25.4mm
 Max. cutting capacity:
 100mm in round pipe
 100x100mm in square steel
 120x100mm in rectangle
 Max. cutting steel bar: 50mm
 With 1 pcs 355mm cutting disc
 Packed by color box



LIST PRICE	Qty/Ctn
10763	1

Cut off saw
COS35 53 8

Voltage:220-240V-50/60Hz
 Input power:2350W
 Blade size:355mmx25.4mm
 No-load speed:3800rpm
 Max. cutting capacity: 100mm in round pipe
 100mmx100mm in square steel
 120mmx100mm in rectangle
 Max. cutting steel bar:50mm
 With 1set extra carbon brushes
 With 1pcs 355mm cutting disc
 Packed by color box



LIST PRICE	Qty/Ctn
12161	1

Cut off saw
COS243558

Voltage:220-240V-50/60Hz
 Input power:2400W
 No-load speed:3900rpm
 Blade size:355mmx25.4mm
 Max. cutting capacity: 100mm in round pipe
 100mmx100mm in square steel
 120mmx100mm in rectangle
 Max. cutting steel bar:50mm
 With 1pcs 355mm cutting disc
 Packed by color box



LIST PRICE	Qty/Ctn
12727	1

Cut off saw
COS4051

Voltage:220-240V-50Hz
 Input power:3.0kW(4HP)
 No-load speed:2280rpm
 Blade size:405mmx25.4mm
 Max. cutting capacity:
 Steel tube:135mmx6mm
 Angle iron:100mmx10mm
 Channel steel:126mmx53mm
 Steel bar:50mm
 Tongs rotary angle:0°-45°
 With 1 pcs abrasive cutting disc
 Packed by wooden case



LIST PRICE	Qty/Ctn
29108	1

Mitre saw
BM S1800 7

Voltage: 220-240V-50/60Hz
 Input power: 1800W
 No-load speed: 5300rpm
 Blade size: 255mmx25.4mm
 Cutting capacity:
 Mitre/Bevel:HeightxWidth
 0°x0°:H70mmxW140mm
 45°x0°:H70mmxW100mm
 0°x45°:H48mmxW135mm
 45°x45°:H48mmxW95mm
 Mitre cuts 0-45° left and right
 Bevel cuts up to 45° to the left
 Include: 1 Set extra carbon brushes
 2 Pcs extension bars



LIST PRICE	Qty/Ctn
17012	1

Mitre saw
BM 2S180 01 7

Voltage: 220-240V-50/60Hz
 Input power: 1800W
 No-load speed: 5300rpm
 Blade size: 255mmx25.4mm
 Parallel dual sliding rails
 Max. cutting capacity: 89mmx320mm
 Cutting capacity: Mitre/Bevel:HeightxWidth
 0°x0°:H89mmxW320mm
 45°x0°:H42mmxW320mm
 0°x45°:H89mmxW210mm
 45°x45°:H42mmxW210mm
 Mitre cuts 0-45° left and right
 Bevel cuts up to 45° to the left
 Include:



LIST PRICE	Qty/Ctn
23239	1

TCT saw blade for aluminum
TSB3305212

305mm(12") 120T, arbor:30mm
 16mm and 25.4mm ring
 Suitable for mitre saw
 For item BM2S24007
 Aluminum cutting
 Packed by color box



LIST PRICE	Qty/Ctn
3437	10

Mitre saw
BM IS160 02

Voltage:220-240V-50Hz
 Input power:1600W
 No-load speed:2800rpm
 Blade size:305mmx30mm
 Induction motor
 Max. cutting capacity:60mmx185mm
 Mitre cuts 0-45° left and right
 Bevel cuts up to 45° to the left
 With 2pcs extension bars
 With 1pcs TCT blade
 With 1pcs dust bag
 Packed by color box



LIST PRICE	Qty/Ctn
35565	1

TCT saw blade for aluminum

TSB3254210

254mm(10")
100T arbor:30mm
16mm and 25.4mm ring
Suitable for mitre saw
For item BM25180017
Aluminum cutting
Packed by color box

LIST PRICE	Qty/Ctn
2272	25

Table saw

TS15007

Voltage: 220-240V~50/60Hz
Input power: 1500W
No-load speed: 4500rpm
Blade size: 254mmx16mm
Max cutting capacity: 85mm(90°)x60mm(45°)
Blade tilting range: 0°-45°
Main table size: 430mmx638mm
Extension table size (left/right): 638mmx150mm
With rip fence, push sticker
With mitre gauge
Packed by carton box

LIST PRICE	Qty/Ctn
28007	1

Table saw

TS26005

Voltage:220-240V~50/60Hz Input power:2600W No-load speed:4800rpm
Blade size:254mmx25.4mm Max cutting capacity: 45 degree:60mm 90 degree:86mm Main table size:643mmx549mm Extension table size left :643mmx65mm Extension table size right:643mmx101mm Extension table size(rear): 549mmx60mm Positive stops at 90° and 45° 4-leg steel stand for rigidity and stability With 1set extra carbon brushes

LIST PRICE	Qty/Ctn
43576	1

Drill press

DP133505

Voltage:220-240V~50Hz Input power:350W
No-load speed:580-2650rpm
Max.drilling capacity:13mm
Adjustable working table
Spindle speed settings:5
Spindle travel:50mm
Column diameter:46mm
Table size:160mmx160mm
Base size:291mmx183mm
Net weight:19Kgs
Machine height:590mm
Packed by color box

LIST PRICE	Qty/Ctn
10828	1

Bench grinder

BG61 50 2

Voltage:220-240V~50Hz Input power:150W
No-load speed:2950rpm
Wheel size:150mm
Adjustable work rest
Heavy duty aluminum base
Include 1set eye shields
Include 1pcs tool storage box
Packed by carton box

LIST PRICE	Qty/Ctn
3750	1

Bench grinder

BG83 50 2

Voltage:220-240V~50Hz Input power:350W
No-load speed:2950rpm
Wheel size:200mm
Adjustable work rest
Heavy duty aluminum base
Include 1set eye shields
Include 1pcs tool storage box
Packed by carton box

LIST PRICE	Qty/Ctn
7370	1

Auto air compressor

AAC1408

Voltage:12V Current:10A
Max pressure:140PSI/10BAR
Max air flow:35L/min
Integrated work light
With 1pcs 3m cord with cigarette lighter
With 1pcs battery clips
With 4pcs adaptors
Packed by color box

LIST PRICE	Qty/Ctn
2742	8

Auto air compressor

AAC1601

Voltage:12V
Max pressure:160PSI/11Bar
Max air flow:35L/min
Integrated work light
With 1pcs 3m cord with cigarette lighter
With 3pcs adaptors
Packed by color box

LIST PRICE	Qty/Ctn
4011	10

Air spray gun

ASG4041

Standard nozzle:1.5mm
Pattern width:180-250mm
Paint capacity:400cc
Suitable for base coat
With Europe type connector, USA type connector, Nitto type connector and Italy type connector.
Optional nozzle:1.2-1.8mm
Operating pressure:3-4bar
Air cons:4.2-7.1cfm(119-200l/min)
Packed by color box

LIST PRICE	Qty/Ctn
1446	10

Air spray gun

ASG3101

Standard nozzle:1.5mm
Pattern width:140-180mm
Paint capacity:1000cc
Suitable for base coat
With Europe type connector, USA type connector, Nitto type connector and Italy type connector.
Optional nozzle:1.2-1.8mm
Operating pressure:3-4bar
Air cons:4.2-7.1cfm(119-200l/min)
Packed by color box

LIST PRICE	Qty/Ctn
1559	10

Air spray gun
ASG1061

Standard nozzle:1.4mm
 Pattern width:180-250mm
 Paint capacity:600cc
 Suitable for finishing coat
 With Europe type connector, USA type connector, Nitto type connector and Italy type connector.
 Optional nozzle:1.3-2.5mm
 Operating pressure:2-3.5bar
 Air cons:4.2-7.1cfm(119-200l/min)
 Packed by color box



LIST PRICE	Qty/Ctn
2020	10

Air washing gun
AWG1001

Nozzle size:215mm
 Washing capacity:0.75L
 With Europe type connector, USA type connector, Nitto type connector and Italy type connector.
 Operation pressure:4bar
 Packed by color box(one color box packs two pieces of AWG1001)



LIST PRICE	Qty/Ctn
843	10

Air tire inflating gun
ATG 060 1

Max pressure:8.5Bar(120PSI)
 With Europe type connector, USA type connector, Nitto type connector and Italy type connector.
 Packed by sliding card



LIST PRICE	Qty/Ctn
1078	20

Air blow gun
AB G0 31 -3

Nozzle length:16mm
 Only with Nitto type connector.
 Packed by sliding card



LIST PRICE	Qty/Ctn
278	50

5 Pcs air tools set
AKT0 05 3 -3

Air tools 5pcs set Only with Nitto type connector. Recoil hose
 Length:4m,Diameter:8mm Air blow gun Nozzle length:16mm
 Air spray gun Operating pressure:3-4bar Paint capacity:600cc
 Pattern width:180-250mm Air washing gun Operation pressure:4bar
 Washing capacity:750cc Air tire inflating gun



LIST PRICE	Qty/Ctn
2724	10

Air impact wrench set
AIW 12 31 2

Square drive:12.5mm(1/2")
 No-load speed:7000 rpm
 Max.torque:312Nm(230ft)
 Weight: 4.2KG
 With 10 pcs socket (9, 10, 11, 13, 14, 17, 19, 22, 24, 27mm)
 With Europe type connector, USA type connector, Nitto type connector and Italy type connector.
 Air Consumption:142.5l/min(5.0cfm)
 Air Pressure:6.3bar(90psi)
 Length:187mm(7.3")
 Weight:4.2kgs(9.3lbs)
 Air Inlet:1/4"



LIST PRICE	Qty/Ctn
5785	6

Air impact wrench
AIW 12 56 2

Square drive:12.5mm(1/2")
 No-load speed:7000/min
 Max.torque:610Nm(450Ft-lb)
 Weight: 2.6KG
 Twin hammer mechanism
 With 3 pcs socket (17mm,19mm,21mm)
 With Europe type connector, USA type connector, Nitto type connector and Italy type connector.
 Air Consumption:142.5l/min(5.0cfm)
 Air Pressure:6.3bar(90psi)
 Length:187mm(7.3")
 Weight:2.6kgs(5.7lbs)
 Air Inlet:1/4"



LIST PRICE	Qty/Ctn
6540	6

10 Pcs 1/2"DR. impact socket set
HKISSD12101

10 Pcs 1/2"DR. impact socket set
 Material:CrMo
 Size:10.12.13.14.15.17.19.21.22.24mm
 Heat treatment
 Packed by BMC



LIST PRICE	Qty/Ctn
1402	12

10 Pcs 1/2" deep impact socket set
HKISSD12102L

10 Pcs 1/2"DR. deep impact socket set
 Size:10.12.13.14.15.17.19.21.22.24mm
 length:78mm
 Material:CrMo
 Heat treatment
 Packed by BMC



LIST PRICE	Qty/Ctn
2211	10

Air impact wrench
AIW341302

Square drive:19mm(3/4")
 No-load speed:4000 rpm
 Max.torque:1600Nm(1180ft)
 Twin hammer mechanism
 With universal connector.
 Air Consumption:256l/min(9cfm)
 Air Pressure:6.3bar(90psi)
 Length:234mm(9.2")
 Weight:5.9kgs(13lbs)
 Air Inlet:3/8"
 Air hose:1/2"
 Packed by color box



LIST PRICE	Qty/Ctn
12526	4

Air impact wrench
AIW 11 22 3

Square drive:25mm(1")
 No-load speed:4000 rpm
 Max.torque:1800Nm(1328ft)
 Twin hammer mechanism
 With universal connector.
 Air Consumption:256l/min(9cfm)
 Air Pressure:6.3bar(90psi)
 Length:234mm(9.2")
 Weight:5.9kgs(13lbs)
 Air inlet:3/8"
 Air hose:1/2"
 Packed by color box



LIST PRICE	Qty/Ctn
14183	4

Air impact wrench
AIW 11 22 2

Square drive:25.4mm(1")
 No-load speed:3600/min
 Max.torque:3100Nm(2220Ft-Lb)
 Weight: 18.5KG
 With universal connector.
 Air Consumption:36Cfm(1019l/min)
 Anvil:200mm(8")
 Capacity bolt Size:45mm(1-3/4")
 Air inlet:1/2"
 Air hose:5/8"
 Packed by BMC



LIST PRICE	Qty/Ctn
24297	1

Air sander
APS1512

Sanding pad:6"(150mm)
 Air Inlet(PT):1/4"
 With Europe type connector, USA type connector, Nitto type connector and Italy type connector.
 No-load Speed RPM:10500
 Air Hose(ID):3/8"
 Air Cons:3cfm(84l/min)
 Air pressure:90PSI,6.3bar
 Packed by color box



LIST PRICE	Qty/Ctn
4887	10

Air ratchet wrench
ARW 12 1

Square Drive: 12.7mm(1/2")
 No-load speed:160RPM
 Max.torque:68N.m(50Ft-Lb)
 With Europe type connector, USA type connector, Nitto type connector and Italy type connector.
 Front Exhaust
 Capacity Bolt Size:1/2"(13mm)
 Air Inlet (NPT): 1/4"
 Air Hose(ID): 3/8"
 Packed by color box



LIST PRICE	Qty/Ctn
4095	10

2 In 1 combo brad nailer
ACN 50 40 1

Load capacity:100Pcs
 Brad size:15-50mm
 Ga18,1.25X1.0mm
 Staple size:16-40mm
 Ga18,1.25X1.0mm
 Staple crown:5.7mm
 With Europe type connector, USA type connector, Nitto type connector and Italy type connector.
 Operation pressure:0.4-0.7Mpa(60-100Psi)
 With 1000pcs brad nails
 With 200pcs staples
 Packed by color box



LIST PRICE	Qty/Ctn
3936	5

Air grease lubricator
AGL02301

Capacity:30L
 Drum application:330*430mm
 Pressure ratio: 50:1
 Working pressure:6-8bar
 Max.free flowrate:850g/min
 Max.fluid pressure:400bar
 Cylinder dia:70mm
 Air consumption:250L/min@6.2bar
 1/4" inlet and outlet air regulator with water filtering device
 Grease hose:5M
 Weight:15KG
 Packed by carton box



LIST PRICE	Qty/Ctn
20518	1

Gasoline chain saw
GCS54 51 81 1

Displacement:46cc
 Rated power:1.8kW
 Engine idle speed:3100±300rpm
 Max. cutting diameter:445mm(18")
 Easy start
 Fuel tank capacity:550ml
 Oil tank capacity:260ml
 Powerful 2-stroke motor
 18" chain saw
 With saw chain AGSC51801
 With chain saw bar AGSB51801
 Packed by color box



LIST PRICE	Qty/Ctn
13205	2

Saw chain
AGSC51 80 1

18" Saw chain
 Suitable for GCS5451811 gasoline chain saw
 Packed by double blister



LIST PRICE	Qty/Ctn
1440	50

Chain saw bar
AGSB51801

18" Chain Saw Bar
 Suitable for GCS5451811 gasoline chain saw
 Packed by double blister



LIST PRICE	Qty/Ctn
1412	25

Gasoline grass trimmer and brush cutter
GB5 434 42 1

Displacement:42.7cc
 Rated power:1.25Kw(2HP)
 Max speed:8000rpm
 Max cutting path:420mm
 Fuel inlet pipe:double-deck PUR pipe
 Easy start
 Spool liner:2.4mmx4m
 Blade diameter:255mm(3teeth)
 Fuel tank capacity:1200ml
 Powerful 2-stroke motor
 With 2 function:trimmer and cutter
 Air cooled engine,single cylinder
 With line spool ALS25405
 With bush cutter blade ABCB05



LIST PRICE	Qty/Ctn
15660	2

Earth auger
GEA55 22 1 -1

Rated power(cc,wattolt):52cc/1.4kw
 Auger speed:0-265/min
 With GEA55221-2 Used Together, GEA55221-2 sold separately.
 Fuel inlet pipe:double-deck PUR pipe
 2-stroke
 Fuel tank capacity: 1200ml
 Max. engine speed: 9000/min
 Max. idle speed:3300±300
 Packed by carton box



LIST PRICE	Qty/Ctn
20723	1

Earth auger bits
GEA55 22 1 -2

Auger bit length:Φ150mm*80cm
 Suitable for GEA55221-1
 Packed by carton box



LIST PRICE	Qty/Ctn
2777	1

Gasoline tiller
GC6101

Petrol Engine
 Engine power:4.8kW(6.5HP)
 Tilling Scope(mm):900
 Driving model:Belt
 Tilling depth(mm):150-300
 Gear shifting:1,0,2,1
 Max. torque(N.m/rpm):11/2500
 Transmission oil capacity(L):0.95
 Packed by carton box



LIST PRICE	Qty/Ctn
68146	1

Electric lawn mower
LM 38 5

Voltage:220V-240V-50/60Hz
 Input Power:1600W
 No-load speed:3500rpm
 Carbon brush motor
 Cutting width:380mm
 Cutting height:28/48/68mm
 Grass box size:45L
 With 0.35m power cord
 Packed by color box



LIST PRICE	Qty/Ctn
10624	1

Vacuum cleaner
VC10101

Voltage: 220V-240V-50/60Hz
 Input power:1000W
 Dust capacity:10L
 Vacuum pressure: ≥15KPa
 Wet and dry cleaning
 Sponge&cloth bag filter
 Air flow:≥1.3m³/min
 Product size:270*255*342mm
 With thermo fuse
 1.2m flexible hose
 1pcs small brush
 1pcs cloth dust bag
 1pcs sponge
 1pcs paper dust bag



LIST PRICE	Qty/Ctn
4407	1

Vacuum cleaner
VC14122

Voltage: 220V-240V-50/60Hz
 Input power: 800W
 Copper wire motor
 Metal tank
 Dust capacity:12L
 Air flow:1.7m³/min
 Vacuum pressure:16KPa
 1.5m flexible hose
 Plastic three parts tube
 1pcs plastic floor brush
 1set 2 in 1 brush
 2.3m cord length
 HEPA filter
 Wet and dry cleaning



LIST PRICE	Qty/Ctn
6294	1

Vacuum cleaner
VC14301

Voltage: 220V-240V-50/60Hz
 Input power: 1400W
 Air flow:1.9CBM/Min
 Vacuum pressure:16-18KPa
 Dust capacity:30L
 1pcs flexible hose
 1pcs floor brush
 1set plastic tube
 1pcs HEPA filter
 Tank material:stainless steel
 Power cable:1.8m
 With power tools socket
 Wet and dry cleaning
 Packed by carton box



LIST PRICE	Qty/Ctn
13378	1

Air-inlet HEPA
VCAIHP02

Suitable for VC14122 UVC14122 VC14301
 UVC14301 Vacuum cleaner
 Filter level:F8
 Packed by plastic bag



LIST PRICE	Qty/Ctn
385	24

High pressure washer
HPWR12008

Voltage: 220-240V-50/60Hz
 Carbon brush motor
 Input power:1200W
 Max Pressure:90Bar (1300PSI)
 Flow rate:5.5L/min
 Aluminum wire motor
 Auto stop system
 1 set unique design spray gun
 3m high pressure hose
 Packed by carton box



LIST PRICE	Qty/Ctn
7525	1

High pressure washer
HPWR14008

Voltage: 220-240V-50/60Hz
 Carbon brush motor
 Pure copper wire
 Input power:1400W
 Max Pressure:130Bar (1900PSI)
 Flow rate:5.5L/min
 Auto stop system
 1 set water spray gun (AMSG028)
 5m high pressure hose(AHPH5028)
 Packed by color box



LIST PRICE	Qty/Ctn
8426	1

High pressure washer
HPWR18008

Voltage: 220-240V~50/60Hz
 Carbon brush motor
 Pure copper wire
 Input power:1800W
 Max Pressure:150Bar (2200PSI)
 Flow rate:6.0L/min
 Auto stop system
 1 pcs soap bottle
 1 set water spray gun (AMSG028)
 5m high pressure hose(AHPH5028)
 Packed by color box



LIST PRICE	Qty/Ctn
13129	1

Spray gun(Quick connector)
AMSG028

Material:Plastic body
 Quick connector
 Suitable for HPWR14008 UHPWR14008
 HPWR18008 UHPWR18008 HPWR20008
 HPWR25008 UHPWR25008
 Packed by color box



LIST PRICE	Qty/Ctn
2076	14

Foam producer
AM FP 40 02

Capacity:400mL
 With adjustable function
 Suitable for AMSG028
 Dimension:125*85*196mm
 Packed by label



LIST PRICE	Qty/Ctn
613	25

High pressure hose(Quick connector)
AHPH5028

Length:5 Meters
 Material:PVC
 Quick connector
 Suitable for HPWR14008 UHPWR14008
 HPWR18008 UHPWR18008 HPWR20008
 Packed by color box



LIST PRICE	Qty/Ctn
1262	16

High pressure washer
HPWR15028

Voltage: 220-240V~50Hz
 Copper wire induction motor
 Input power:1500W
 Max Pressure:100Bar (1450PSI)
 Flow rate:6.7L/min
 1 set water spray gun
 8m high pressure metal hose
 Packed by color box



LIST PRICE	Qty/Ctn
13381	1

High pressure washer(For commercial use)
HPWR30018

Voltage: 220-240V~50Hz
 Copper pump
 Copper wire induction motor
 Input power: 2400W
 Max Pressure: 100Bar (1450PSI)
 Flow rate: 10L/min
 500 hours lifetime
 1 set metal spray gun
 4 types of nozzles
 8m high pressure hose(steel wired)
 Net weight : 24kg
 Packed by carton box



LIST PRICE	Qty/Ctn
34057	1

Chalk line reel
HCLR0 13 0

Chalk line reel
 Length:30m
 With 1 bottle chalk
 With 1 pcs spirit bubble
 With 1 pcs blue powder bottle: 4oz/113g
 Packed by double blister



LIST PRICE	Qty/Ctn
354	40

Spirit level
HSL18030

Length: 30cm
 Aluminum
 Aluminum thickness:1mm
 Packed by color sleeve



LIST PRICE	Qty/Ctn
297	40

8 Pcs HSS twist drill bits set
AKDB0801

8PCS/SET
 Size: 2X49,3X61, 3X61, 4X75, 4X75 ,
 5X86,6X93, 8X117
 8pcs HSS rolling twist drill bits set
 Packed by double blister



LIST PRICE	Qty/Ctn
167	80

12 Pcs HSS twist drill bits set
AKDB1125

12pcs HSS twist drill bits set
 Size: 2,2.5,3,3.5,4,4.5,5,5.5,6,6.5,7,8mm
 Packed by double blister



LIST PRICE	Qty/Ctn
359	40

5 Pcs masonry drill bits set

AKDB3055

Size: 4X75, 5X85, 6X100, 8X120, 10X120
5PCS Masonry drill bits set
Packed by double blister



LIST PRICE	Qty/Ctn
221	80

5 Pcs SDS plus hammer drill bits set

AKD2052

6X110mm,8X110mm,8X160mm,10X160mm,12X160mm
5 pcs SDS Plus hammer drill bits set
Packed by plastic box



LIST PRICE	Qty/Ctn
579	30

19 Pcs drill bits & screwdriver bits set

AKSDB1901

19PCS drill bits & setscrewdriver bits set
7pcs HSS Rolling twist drill bits
SIZE:2,3,3.5,4,4.5,6mm
4pcs Masonry drill bits
SIZE:4,5,6,8mm
8PCS 25mm Screwdriver bits
SL4.5,SL5.5,PH1,PH2,PZ1,PZ2,T20,T30/
Packed by double blister



LIST PRICE	Qty/Ctn
369	40

Impact socket adaptor

AMN365A01

3pcs/set
1/4", 3/8", 1/2"
Shank:1/4" Hex
Material:50BV30
Length:165mm(1/4", 3/8")
Length II:73mm(1/2")
Packed by sliding card



LIST PRICE	Qty/Ctn
209	100

6 Pcs screw extractor set

ASE106

Material:Cr-V
Size:3-6mm(1#),6-8mm(2#),8-11mm(3#),11-14mm(4#),14-18mm(5#),18-25mm(6#)
Hardness:48-52HRC
Coarse thread
Packed by double blister



LIST PRICE	Qty/Ctn
560	50

Bi-metal hole saw set

AKH0071

7Pcs Bi-metal hole saw set
Size: 19mm(3/4"),22mm(7/8"),29mm(1-1/8"),32mm(1-1/4"),35mm(1-3/8")
1 Pcs adapter: 1/2"-20" threads to fit hole saws 5/8"-18"thread
1 pcs arbor: 3/8" Hex Shank, Fit Size: 9/16"-1-3/16"
Packed by double blister



LIST PRICE	Qty/Ctn
1402	40

Bi-metal hole saw set

AKH0121

Hole saw 12pcs set
Size:20mm(25/32"),22mm(7/8"),25mm(1"),29mm(1-1/8"),32mm(1-1/4"),35mm(1-3/8"),38mm(1-1/2"),44mm(1-3/4"),48mm(1-7/8"),50mm1-31/32")
1 pcs arbor: 1/4" Round Shank, Fit Size: 9/16"-1-3/16"
1 pcs arbor: 7/16" Hex Shank, Fit Size: 1-1/4"-8-17/64"
Packed by Aluminum case



LIST PRICE	Qty/Ctn
4845	10

Arbor for hole saw

HSA01

Arbor for hole saw
Hex shank 3/8"
Fit hole saws 14mm to 30mm
Packed by double blister



LIST PRICE	Qty/Ctn
262	120

Arbor for hole saw

HSA02

Arbor for hole saw
Hex shank 7/16"
Fit hole saws 32mm to 210mm.
Packed by double blister



LIST PRICE	Qty/Ctn
541	60

HSS bi-metal hole saw

HSB10161

Diameter:16mm (5/8")
Cutting depth:38mm (1 1/2")
Material:HSS M3 Bi-metal
Variable teeth 4/6
Packed by double blister



LIST PRICE	Qty/Ctn
191	50

HSS bi-metal hole saw

HSB10191

19mm (3/4")

Diameter: 19mm (3/4")
 Cutting depth: 38mm (1 1/2")
 Material: HSS M3 Bi-metal
 Variable teeth 4/6
 Packed by double blister

BIM



LIST PRICE	Qty/Ctn
227	50

HSS bi-metal hole saw

HSB10221

22mm (7/8")

Diameter: 22mm (7/8")
 Cutting depth: 38mm (1 1/2")
 Material: HSS M3 Bi-metal
 Variable teeth 4/6
 Packed by double blister

BIM



LIST PRICE	Qty/Ctn
257	50

HSS bi-metal hole saw

HSB10251

25mm (1")

Diameter: 25mm (1")
 Cutting depth: 38mm
 Material: HSS M3 Bi-metal
 Variable teeth 4/6
 Packed by double blister

BIM



LIST PRICE	Qty/Ctn
288	50

HSS bi-metal hole saw

HSB10321

32mm (1-1/4")

Diameter: 32mm (1-1/4")
 Cutting depth: 38mm
 Material: HSS M3 Bi-metal
 Variable teeth 4/6
 Packed by double blister

BIM



LIST PRICE	Qty/Ctn
361	50

HSS bi-metal hole saw

HSB10351

35mm (1-3/8")

Diameter: 35mm (1-3/8")
 Cutting depth: 38mm
 Material: HSS M3 Bi-metal
 Variable teeth 4/6
 Packed by double blister

BIM



LIST PRICE	Qty/Ctn
392	50

HSS bi-metal hole saw

HSB10381

38mm (1-1/2")

Diameter: 38mm (1-1/2")
 Cutting depth: 38mm (1 1/2")
 Material: HSS M3 Bi-metal
 Variable teeth 4/6
 Packed by double blister

BIM



LIST PRICE	Qty/Ctn
416	50

HSS bi-metal hole saw

HSB10441

44mm (1-3/4")

Diameter: 44mm (1-3/4")
 Cutting depth: 38mm (1-1/2")
 Material: HSS M3 Bi-metal
 Variable teeth 4/6
 Packed by double blister

BIM



LIST PRICE	Qty/Ctn
461	50

HSS bi-metal hole saw

HSB10461

46mm (1-13/16")

Diameter: 46mm (1-13/16")
 Cutting depth: 38mm (1-1/2")
 Material: HSS M3 Bi-metal
 Variable teeth 4/6
 Packed by double blister

BIM



LIST PRICE	Qty/Ctn
466	50

HSS bi-metal hole saw

HSB10511

51mm (2")

Diameter: 51mm (2")
 Cutting depth: 38mm (1 1/2")
 Material: HSS M3 Bi-metal
 Variable teeth 4/6
 Packed by double blister

BIM



LIST PRICE	Qty/Ctn
484	50

HSS bi-metal hole saw

HSB10641

64mm (2-1/2")

Diameter: 64mm (2-1/2")
 Cutting depth: 38mm (1 1/2")
 Material: HSS M3 Bi-metal
 Variable teeth 4/6
 Packed by double blister

BIM



LIST PRICE	Qty/Ctn
609	50

HSB10761 **HSS bi-metal hole saw**

Diameter:76mm (3")
Cutting depth:38mm (1 1/2")
Material:HSS M3 Bi-metal
Variable teeth 4/6
Packed by double blister

BIM **76mm(3")**

LIST PRICE	Qty/Ctn
727	50

HBP81016 **Ball pein hammer**

Weight:16oz/450g
Innovated drop-forged hammer head
Heat treatment,45# carbon steel
Strong three-color fiberglass handle for comfortable gripe
Packed by label

Fiberglass handle 16oz

Drop forged

LIST PRICE	Qty/Ctn
424	18

HCH81016 **Claw hammer**

Weight:16oz/450g
Magnetic nail function
Innovated drop-forged hammer head
Heat treatment,45# carbon steel
Strong three-color fiberglass handle for comfortable grip
Packed by label

Fiberglass handle 16oz

Drop forged

LIST PRICE	Qty/Ctn
458	18



HM H822 00 **Machinist hammer**

Weight:200g
Innovated drop-forged hammer head
Heat treatment,45# carbon steel
Strong three-color fiberglass handle for comfortable gripe
Packed by label

Fiberglass handle 200g

Drop forged

LIST PRICE	Qty/Ctn
268	48

HM H823 00 **Machinist hammer**

Weight:300g
Innovated drop-forged hammer head
Heat treatment,45# carbon steel
Strong three-color fiberglass handle for comfortable gripe
Packed by label

Fiberglass handle 300g

Drop forged

LIST PRICE	Qty/Ctn
319	36

HM H825 00 **Machinist hammer**

Weight:500g
Innovated drop-forged hammer head
Heat treatment,45# carbon steel
Strong three-color fiberglass handle for comfortable gripe
Packed by label

Fiberglass handle 500g

Drop forged

LIST PRICE	Qty/Ctn
404	24

HSTHS81000 **Stoning hammer**

Weight:1000g
Drop-forged hammerhead
Heat treatment,45# carbon steel
Unique design fiberglass handle
Packed by label

Fiberglass handle 1000g

Drop forged

LIST PRICE	Qty/Ctn
580	12

HRUH8208 **Rubber hammer**

Weight:8oz/220g
Rubber hammerhead
Non-spark
Non-marring plastic faces
Protect workpiece surface
Unique design fiberglass handle
Packed by label

Fiberglass handle 8oz

Rubber

LIST PRICE	Qty/Ctn
272	40

HRUH8216 **Rubber hammer**

Weight:16oz/450g
Rubber hammerhead
Non-spark
Non-marring plastic faces
Protect workpiece surface
Unique design fiberglass handle
Packed by label

Fiberglass handle 16oz

Rubber

LIST PRICE	Qty/Ctn
334	24

Dead blow mallet

HDBM01028

Dead blow mallet
Weight: 2LB
Non-marring plastic faces
Non-rebounding
Non-spark
Unique design fiberglass handle
Packed by label

Fiberglass handle 2LB





LIST PRICE	Qty/Ctn
868	24

7 Pcs Body And Fender Hammer Set

HBAFH0712

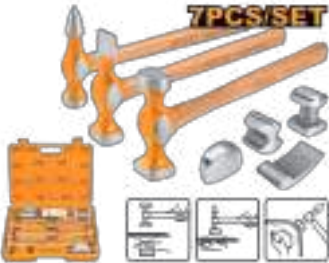
7 Pcs Body And Fender Hammer Set
Genuine Hickory handle
1Pcs Chisel end hammer
1Pcs Pick hammer
1Pcs Bumping hammer
1Pcs Shrinking dolly
1Pcs Double end dolly
1Pcs Curved dolly
1Pcs Heel dolly
Drop-forged hammerhead
Heat treatment, 45# carbon steel
Packed by BMC



LIST PRICE	Qty/Ctn
4367	2

Ball pein hammer

HBPHS8016

Weight: 16oz/450g Drop-forged hammerhead Heat treatment, 45# carbon steel Unique design fiberglass handle Packed by label

Fiberglass handle 16oz



LIST PRICE	Qty/Ctn
429	18

Ball pein hammer

HBPH88032

Weight: 32oz/900g Drop-forged hammerhead Heat treatment, 45# carbon steel Unique design fiberglass handle Packed by label

Fiberglass handle 32oz



LIST PRICE	Qty/Ctn
681	18

Axe

HAX 08 160 0

Weight: 600g Innovated drop-forged axe head Heat treatment, 45# carbon steel Strong three-color fiberglass handle for comfortable gripe Packed by label

Fiberglass handle 600g



LIST PRICE	Qty/Ctn
665	12

Axe

HAX S 206 00 1

Weight: 600g Drop-forged axe head Heat treatment, 45# carbon steel Unique design fiberglass handle Packed by label

Fiberglass handle 600g



LIST PRICE	Qty/Ctn
679	12

Combination pliers

HCP08 168

Size: 6"/160mm
Polish and anti-rust oil
Two color handle
Packed by sliding card

160mm(6)



LIST PRICE	Qty/Ctn
310	36

Combination pliers

HCP12 200

Size: 8"/200mm
Polish and anti-rust oil
One color handle
Packed by sliding card

200mm(8)



LIST PRICE	Qty/Ctn
372	60

Combination pliers

HCP08 208

Size: 8"/200mm
Polish and anti-rust oil
Two color handle
Packed by sliding card

200mm(8)



LIST PRICE	Qty/Ctn
367	36

Long nose pliers

HLNP12160

Size: 6"/160mm
Polish and anti-rust oil
One color handle
Packed by sliding card

160mm(6)



LIST PRICE	Qty/Ctn
270	60

Long nose pliers

HLNP08168

Size: 6"/160mm
Polish and anti-rust oil
Two color handle
Packed by sliding card



160mm(6")

LIST PRICE	Qty/Ctn
270	36

Long nose pliers

HLNP08208

Size: 8"/200mm
Polish and anti-rust oil
Two color handle
Packed by sliding card



200mm(8")

LIST PRICE	Qty/Ctn
319	36

Diagonal cutting pliers

HDPC08168

Size: 6"/160mm
Polish and anti-rust oil
Two color handle
Packed by sliding card



160mm(6")

LIST PRICE	Qty/Ctn
296	36

End cutting pliers

HECP28160

Size: 6"/160mm
Cr-V, black finish and polish
TPR two color handle
Packed by PP hanger



CrV 160mm(6")

LIST PRICE	Qty/Ctn
431	36

Rabbit pliers

HRP02 230

Size: 9"/228mm
Cr-V, black finish and polish
With plastic handle
Packed by PP hanger



CrV 228mm(9")

LIST PRICE	Qty/Ctn
404	36

Mini long nose pliers

HM LNP 08 11 5

Size: 4.5"/115mm
Polish and anti-rust oil
Two color handle
Packed by sliding card



115mm(4.5")

LIST PRICE	Qty/Ctn
220	120

Mini end cutting pliers

HM BCD081 15

Size: 4.5"/115mm
Polish and anti-rust oil
Two color handle
Packed by sliding card



115mm(4.5")

LIST PRICE	Qty/Ctn
223	120

Mini combination pliers

HMCP08115

Size: 4.5"/115mm
Polish and anti-rust oil
Two color handle
Packed by sliding card



115mm(4.5")

LIST PRICE	Qty/Ctn
215	120

Mini diagonal cutting pliers

HM DCP081 15

Size: 4.5"/115mm
Polish and anti-rust oil
Two color handle
Packed by sliding card



115mm(4.5")

LIST PRICE	Qty/Ctn
215	120

Mini needle nose pliers

HMNNP08115

Size: 4.5"/115mm
Polish and anti-rust oil
Two color handle
Packed by sliding card



115mm(4.5")

LIST PRICE	Qty/Ctn
215	120

Plastic cutting pliers

HDCP38160

Size: 6"/160mm
Black finish and polish
With plastic handle
Packed by sliding card

160mm(6")

Cut plastic

LIST PRICE	Qty/Ctn
325	36

3 Pcs pliers set

HKPS08318

Size:
8" Combination pliers
6" Long nose pliers
6" Diagonal cutting pliers
Polish and anti-rust oil
Two color handle
Packed by sliding card

160mm(6")
160mm(6")
200mm(8")

3PCS/SET

LIST PRICE	Qty/Ctn
891	20

Pump pliers

HPP28258

Size:10"/250mm
Max clamping open:40mm
Cr-V,black finish and polish
TPR two color handle
Packed by PP hanger

CrV 250mm(10")

LIST PRICE	Qty/Ctn
519	36

Slip joint pliers

HSPJP02200

Size: 8"/200mm
Black finish and polish
Packed by PP hanger

200mm(8")

Black finish and Polish

LIST PRICE	Qty/Ctn
280	36

Curved jaw locking plier

HCJLW 02 10

Carbon steel
Size: 10"
Openings range: 0-50mm
HRC38°-HRC48°
Nickel plated
Packed by half double blister

10"

LIST PRICE	Qty/Ctn
460	30

Straight jaw plier

HSJP0110

Carbon steel
Size: 10"
Openings range: 0-50mm
HRC38°-HRC48°
Nickel plated
Packed by half double blister

10"

LIST PRICE	Qty/Ctn
406	30

Long nose locking plier

HLNP0209

Carbon steel
Size: 9"
Openings range: 0-60mm
HRC38°-HRC48°
Nickel plated
Packed by half double blister

9"

LIST PRICE	Qty/Ctn
469	30

C-clamp locking plier

HCCLW 021 1

Carbon steel
Size: 11"
Openings range: 0-95mm
Weight: 710g
Nickel plated
Same function as HCCLW0111
Packed by plastic hanger

11"

LIST PRICE	Qty/Ctn
709	20

Wire stripper

HWSP15608

Stripper diameter:0.5mm-6mm With cutting function PP covered TPR handle 65Mn material blade Product size:175*85mm Packed by double blister

178mm(7")

LIST PRICE	Qty/Ctn
621	48

Automatic wire stripper

HWSP102418

3 in 1 multi-function
Stripping, cutting and crimping
Stripping wires range:10AWG-24AWG (0.2-6mm²)
Cutting function:Copper and aluminum wires
Crimping function:
Crimp the insulated terminals 0.5-6mm² (10-22 AWG);
Crimp the non-insulated terminals: 0.5-6mm² (4-22 AWG);
Crimp the ignition terminals: 7-8mm²
Durable and comfortable handle
Packed by sliding card

210mm(8-1/4")

CUTTING STRIPPING CRIMPING

LIST PRICE	Qty/Ctn
932	48

Wire stripper

HWSP851

Size: 8.5"/215mm
 With sharp edge for cutting wire
 With push down wire function
 With wire stripping function
 Can strip seven kinds of wire size
 Can cut five kinds of copper screw size
 Packed by sliding card

215mm(8.5)



LIST PRICE	Qty/Ctn
365	72

Wire stripper

HWSP101

Size: 10"/254mm
 With sharp edge for cutting wire
 With push down wire function
 With wire stripping function
 Can strip six kinds of wire size
 Can cut five kinds of copper screw size
 Packed by sliding card

254mm(10)



LIST PRICE	Qty/Ctn
639	72

Modular plug crimper

HMPC1468P

Modular Plug Crimper
 Used for crimping terminals of network line and telephone line
 Crimping range: 4P, 6P, 8P
 Length: 8"
 Three functions: Crimping, Stripping, Cutting
 Unique Design PVC handle
 Packing by blister card

Crimping range: 200mm(8)

4P/6P/8P



LIST PRICE	Qty/Ctn
549	36

Ratchet crimping plier

HRCPG05210

Crimping range: 0.25-10mm²
 For tubular bare terminals and pre-insulated terminals
 AWG: 23-7
 Length: 6"
 Unique design handle
 Pressure force can be adjusted, fit for various terminals
 Packing by sliding card

Crimping range: 160mm(6)

0.25-10mm²



LIST PRICE	Qty/Ctn
1384	40

Circlip pliers

HCCP261801

Straight head circlip Plier
 External circlip plier
 Size: 7"/180mm
 Diameter of the head: 1.8mm
 Material: Cr-V
 Surface treatment: black finish and polish
 Packed by sliding card

180mm(7)



LIST PRICE	Qty/Ctn
362	60

Circlip pliers

HCCP261802

Bent head circlip Plier
 External circlip plier
 Size: 7"/180mm
 Diameter of the head: 1.8mm
 Material: Cr-V
 Surface treatment: black finish and polish
 Packed by sliding card

180mm(7)



LIST PRICE	Qty/Ctn
362	60

Circlip pliers

HCCP261803

Straight head circlip Plier
 Internal circlip plier
 Size: 7"/180mm
 Diameter of the head: 1.8mm
 Material: Cr-V
 Surface treatment: black finish and polish
 Packed by sliding card

180mm(7)



LIST PRICE	Qty/Ctn
362	60

Circlip pliers

HCCP261804

Bent head circlip Plier
 Internal circlip plier
 Size: 7"/180mm
 Diameter of the head: 1.8mm
 Material: Cr-V
 Surface treatment: black finish and polish
 Packed by sliding card

180mm(7)



LIST PRICE	Qty/Ctn
362	60

4 Pcs circlip pliers set

HCCPS26180

4Pcs circlip plier set
 2Pcs of 180°, 2 pcs of 90°
 Size: 7"/180mm
 Material: Cr-V
 Surface treatment: black finish and polish
 Packed by canvas bag

180mm(7")

4PCS/SET



LIST PRICE	Qty/Ctn
1440	30

Cable stripping knife

HPK82001

Size: 200mm
 Curved blade
 Material: Stainless steel
 With plastic protective cover
 Unique design handle
 Sand blast surface
 Packed by double blister

Curved Blade 200mm(8)



LIST PRICE	Qty/Ctn
243	72

Electrician's scissors
HES02855

Size:145mm(5.5")
Material: Stainless steel
Blade thickness:3.0mm
Unique design handle
Sand blast surface
Packed by double blister



LIST PRICE	Qty/Ctn
212	100

Electrician's scissors
HES0188

Size:200mm(8")
Material: stainless steel
With cutting function
Unique design handle
Blade with teeth
Sand blast surface
Packed by double blister



LIST PRICE	Qty/Ctn
353	72

Pipe wrench
HPW0812

Size:12" (300mm)
Max clamping diameter:42mm
Mobile jaw drop-forged with high quality carbon steel
Inactivate treatment
Body material:ductile cast iron
Black finish and polish
Solid rivet
Packed by paper card



LIST PRICE	Qty/Ctn
639	18

Pipe wrench
HPW0814

Size:14" (350mm)
Max clamping diameter:50mm
Mobile jaw drop-forged with high quality carbon steel
Inactivate treatment
Body material:ductile cast iron
Black finish and polish
Solid rivet
Packed by paper card



LIST PRICE	Qty/Ctn
841	12

Pipe wrench
HPW0818

Size:18" (450mm)
Max clamping diameter:60mm
Mobile jaw drop-forged with high quality carbon steel
Inactivate treatment
Body material:ductile cast iron
Black finish and polish
Solid rivet
Packed by paper card



LIST PRICE	Qty/Ctn
1205	10

Pipe wrench
HPW0824

Size:24"
Max clamping diameter:76mm
Mobile jaw drop-forged with high quality carbon steel
Inactivate treatment
Body material:ductile cast iron
Black finish and polish
Solid rivet
Packed by paper card



LIST PRICE	Qty/Ctn
1719	4

Pipe wrench
HPW0836

Size:36"
Max clamping diameter:85mm
Mobile jaw drop-forged with high quality carbon steel
Inactivate treatment
Body material:ductile cast iron
Black finish and polish
Solid rivet
Packed by paper card



LIST PRICE	Qty/Ctn
3266	3

Pipe wrench
HPW0848

Size:48"
Max clamping diameter:110mm
Mobile jaw drop-forged with high quality carbon steel
Inactivate treatment
Body material:ductile cast iron
Black finish and polish
Solid rivet
Packed by paper card



LIST PRICE	Qty/Ctn
4065	2

Ratcheting pipe wrench
HPW1414

Size: 14"/350mm
Clamping diameter:18-52mm
Carbon steel
black finish and polish
Packed by paper card



LIST PRICE	Qty/Ctn
1383	12

Pipe flaring tool set
HPF171

Diameter of pipe:
5mm/6mm/8mm/10mm/12mm/14mm/16mm
Chrome plated steel backplane
Forged steel frame
Packed by sliding card



LIST PRICE	Qty/Ctn
899	24

Aviation snip

HTSN0110S

250mm(10")

Unique design two tone soft handle
Aviation snip(Straight)
Length:250mm (10")
Max.cutting thickness:
Carbon steel ≤1.2mm
Stainless steel ≤0.7mm
Packed by half double blister



LIST PRICE	Qty/Ctn
474	40

Mini bolt cutter

HMBC0808

Size:8"
Cr-MO blade
Black finish and polish
TPR two color handle
A lock at the end of handle
Packed by sliding card



LIST PRICE	Qty/Ctn
388	48

Bolt cutter

HBC0812

Size:12"
Cr-V blade
Black finish and polish
TPR two color handle
Packed by paper card



Comfortable Rubber Handle

LIST PRICE	Qty/Ctn
894	20

Bolt cutter

HBC08 14

Size:14"
Cr-V blade
Black finish and polish
TPR two color handle
Packed by paper card



Comfortable Rubber Handle

LIST PRICE	Qty/Ctn
980	16

Bolt cutter

HBC0818

Size:18"
Cr-V blade
Black finish and polish
TPR two color handle
Packed by paper card



Comfortable Rubber Handle

LIST PRICE	Qty/Ctn
1269	12

Bolt cutter

HBC08 24

Size:24"
Cr-V blade
Black finish and polish
TPR two color handle
Packed by paper card



Comfortable Rubber Handle

LIST PRICE	Qty/Ctn
1679	6

Bolt cutter

HBC0830

Size:30"
Cr-V blade
Black finish and polish
TPR two color handle
Packed by paper card



Comfortable Rubber Handle

LIST PRICE	Qty/Ctn
2369	4

Bolt cutter

HBC08 36

Size:36"
Cr-V blade
Black finish and polish
TPR two color handle
Packed by paper card



Comfortable Rubber Handle

LIST PRICE	Qty/Ctn
3050	3

Bolt cutter

HBC0842

Size:42"
Cr-V blade
Black finish and polish
TPR two color handle
Packed by paper card



Comfortable Rubber Handle

LIST PRICE	Qty/Ctn
4095	2

Cable cutter

HCCB0206

Size:6"/160mm
Black finish and polish
55# Carbon steel
Packed by half double blister



LIST PRICE	Qty/Ctn
330	90

Cable cutter

HCCB0208

Size:8"/200mm
Black finish and polish
55# Carbon steel
Packed by half double blister

LIST PRICE	Qty/Ctn
410	60

Cable cutter

HCCB0210

Size:10"/250mm
Black finish and polish
55# Carbon steel
Packed by half double blister

LIST PRICE	Qty/Ctn
456	48

Heavy duty cable cutter

HHCCB0 210

Heavy duty cable cutter
Size:10"/250mm
Black finish and polish
55# Carbon steel
Packed by half double blister

LIST PRICE	Qty/Ctn
504	36

Cable cutter

HCCB0124

Size:24" Blades material:65Mn Used for cutting copper and aluminum cable Not for self supporting strand Cutting area:240mm² Body heat treatment, cutting edges induction quenched Packed by paper card

LIST PRICE	Qty/Ctn
1833	6

Cable cutter

HCCB0136

Size:36" Blades material:65Mn Used for cutting copper and aluminum cable Not for cutting ACSR , wire rope, steel or self supporting strand Cutting area:450mm² Body heat treatment , cutting edges induction quenched Packed by paper card

LIST PRICE	Qty/Ctn
3356	2

PVC pipe cutter

HPC0535

Length:210mm
Cutting diameter:3-35mm
Material: Aluminum
packed by double blister

LIST PRICE	Qty/Ctn
345	72

PVC pipe cutter

HPCS05428

Length:203mm
Material: 4cr13
Cutting diameter:3-42mm
Auto-open function
New unique handle design
Packed by double blister

LIST PRICE	Qty/Ctn
519	48

PVC pipe cutter

HPC0442

Length:230mm
Cutting diameter:3-42mm
Auto-open function
Packed by double blister

LIST PRICE	Qty/Ctn
763	24

Pipe cutter

HPC0232

Copper and aluminum pipe cutter
Cutting diameter:3-32mm
With high Quality blade
Aluminum knob
Packed by sliding card

LIST PRICE	Qty/Ctn
580	48

Slotted go-through screwdriver

HGTS6 86 15 0

1pcs screwdriver with 1pcs plastic hanger
S2 industrial steel , Hex shank
Slotted: 6.5mm
Shank: 6.0mm
Length: 150mm
Packed by plastic hanger

LIST PRICE	Qty/Ctn
205	144

Slotted go-through screwdriver
HGTS688200

1pcs screwdriver with 1pcs plastic hanger
S2 industrial steel , Hex shank
Slotted: 8mm
Shank: 8.0mm
Length: 200mm
Packed by plastic hanger



LIST PRICE	Qty/Ctn
277	72

Phillips go-through screwdriver
HGTS68PH2150

1pcs screwdriver with 1pcs plastic hanger
S2 industrial steel , Hex shank
Size: PH2
Shank: 6.0mm
length: 150mm
Packed by plastic hanger



LIST PRICE	Qty/Ctn
205	144

Phillips go-through screwdriver
HGTS6 8PH3 20 0

1pcs screwdriver with 1pcs plastic hanger
S2 industrial steel , Hex shank
Size: PH3
Shank: 8.0mm
length: 200mm
Packed by plastic hanger



LIST PRICE	Qty/Ctn
277	72

6Pcs go-through screwdriver set
HS GTDC 18 06 01

6 Pcs Go-through Screwdriver set
Material: Cr-V
1pcs SL5.5*75mm
1pcs SL6.5*100mm
1pcs SL8.0*150mm
1pcs PH1*75mm
1pcs PH2*100mm
1pcs PH3*150mm
with 1 pcs plastic frame
Packed by double blister

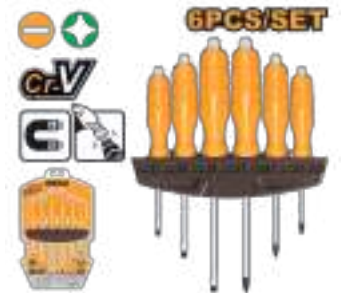

LIST PRICE	Qty/Ctn
665	20

8 IN 1 Stubby ratchet screwdriver set
AKISDS1728

8 IN 1 Stubby ratchet screwdriver set
Material:Cr-V
Include:
1 Pcs ratchet handle,high quality ratchet
7 Pcs 1/4"*25mm screwdriver bits
Size:SL5,SL6,PH0,PH1,PH2,T10,T20
Packed by display color box



LIST PRICE	Qty/Ctn
252	48

13 In 1 ratchet screwdriver set
AKISD1208

13 IN 1 Ratchet Screwdriver set
Include:
1 Pcs Unique design ratchet handle
Folding handle, high quality ratchet
12 Pcs 6.35*25mm screwdriver bits
Size: SL4,SL5,SL6,SL7, PH0,
PH1,PH2,PH3,PZ0,PZ1,PZ2,PZ3
Material: CR-V
Packed by display color box



LIST PRICE	Qty/Ctn
393	48

9 Pcs interchangeable screwdriver set
AKISD0901

Interchangeable screwdriver set
Include:
3pcs SL3X65 SL5X65 SL6X65
3pcs PH0X65 PH1X65 PH2X65
1pcs 5X65 tack remover
1pcs 3X65 scratch awl
Material:CR-V
with 1pcs Unique design Interchangeable
Handle
Packed by plastic box



LIST PRICE	Qty/Ctn
542	48

7 Pcs precision screwdriver set
HKSD0718

7PCS precision screwdriver set
new design handle,New plastic box
Include:
SL2.0*50, SL2.5*50, SL3.0*50, PH00*50,
PH0*50, T6*50, T8*50
Material:CR-V
Ergonomic comfort-grip handle
Packed by plastic box



LIST PRICE	Qty/Ctn
446	120

32 Pcs precision screwdriver set
HKSDB0348

32PCS precision screwdriver set 1Pcs unique
design handle 1Pcs 4X60mm bits holder
30PCS 4X28mm bits:
SL1.5,SL2,SL2.5,SL3,SL3.5,SL4,PH000,PH00
PH0,PH1,T4,T5,T6,T7,T8,T9,T10,T15,T20,H0
.9,H1.3,H1.5,H2,H2.5,H3,H4,Y2,U2.6,Five
Star0.8, Five Star1.2 Five Star0.8, Five
Star1.2 is suitable for iPhone and iPad
Packed by plastic box



LIST PRICE	Qty/Ctn
737	120

24 Pcs t-handle wrench screwdriver set
HKSDB0188

24PCS T-handle wrench screwdriver set
Include:
15pcs 6.35x25MM CR-V screwdriver
bit:SL3,SL4,SL5,SL6,PH0,PH1,PH2,PH3,PZ1,
PZ2,T15,T20,H4,HS,H6
1PC 5X100MM bit holder with strong magnet-
ic
1PC unique design T-handle Ratchet wrench
1PC 4-6mm(25mm)bits adaptor
6PC 1/4" socket: 5,6,7,8,9,10
Packed by plastic box



LIST PRICE	Qty/Ctn
466	36

47 Pcs t-handle wrench screwdriver set

HKSDB0478

47 Pcs T-handle wrench screwdriver set
 Include: 35Pcs 6.35X25mm screwdriver bits:
 SL3 SL4
 SL5 SL6 SL7 PH0 PH1X3 PH2X5 PH3X3 PZ0
 PZ1 PZ2X2 PZ3X2 T10 T15 T20 T25 T27 T30
 T40 H2 H3 H4 H5 H6
 9Pcs 1/4"X20.5mm socket:4 5 6 7 8 9 10 11
 12mm
 1Pcs adaptor
 1Pcs 6.3X139mm bits holder
 1Pcs ratchet handle
 Packed by plastic box



LIST PRICE	Qty/Ctn
1145	24

Hex key

HHK11091

9pcs hex key set
 Material:S2
 Size:1.5mm,2mm, 2.5mm, 3mm, 4mm, 5mm,
 6mm, 8mm, 10mm.
 Long arm
 Heat treatment and chrome plate
 Packed by double blister



LIST PRICE	Qty/Ctn
352	48

Hex key

HHK11 09 2

9pcs hex key set
 Material:S2
 Size:1.5mm,2mm, 2.5mm, 3mm, 4mm, 5mm,
 6mm, 8mm, 10mm.
 Extra-long arm
 Heat treatment and chrome plate
 Packed by double blister



LIST PRICE	Qty/Ctn
454	48

Torx key

HHK13 09 1

9pcs torx key set
 Material:S2
 Size:T-10,T-15,T-20,T-25,T-27,T-30,T-40,T-
 45,T-50.
 Long arm
 Heat treatment and chrome plate
 Packed by double blister



LIST PRICE	Qty/Ctn
434	48

Torx key

HHK13 09 2

9pcs torx key set
 Material:S2
 Size:T-10,T-15,T-20,T-25,T-27,T-30,T-40,T-
 45,T-50.
 Extra-long arm
 Heat treatment and chrome plate
 Packed by double blister



LIST PRICE	Qty/Ctn
514	48

Hex key

HHK14 08 1

8pcs hex key (Pocket)
 Size: 2mm,
 2.5mm,3mm,4mm,5mm,6mm,7mm,8mm.
 Material: Cr-V
 Heat treatment and chrome plate
 Packed by plastic hanger



LIST PRICE	Qty/Ctn
347	96

Ball point hex key

HHK14 08 2

8pcs ball point hex key set(Pocket)
 Size: 2mm,
 2.5mm,3mm,4mm,5mm,6mm,7mm,8mm.
 Material: Cr-V
 Heat treatment and chrome plate
 Packed by plastic hanger



LIST PRICE	Qty/Ctn
338	96

Torx key

HHK14 08 3

8pcs torx key set(Pocket)
 Size: T9,T10,T15,T20,T25,T27,T30,T40.
 Material: Cr-V
 Heat treatment and chrome plate
 Packed by plastic hanger



LIST PRICE	Qty/Ctn
338	96

8 Pcs T-handle hex wrench set

HHKT8 08 18

8 Pcs T-handle hex wrench set
 Size:2X100,2.5X100,3X100,4X150,5X150,6X1
 50,8X200,10X200
 Material:S2,Heat treatment and chrome plate
 Brand exclusive shelf
 Packed by double blister



LIST PRICE	Qty/Ctn
1038	10

8 Pcs T-handle torx wrench set

HHKT8 08 38

8 Pcs T-handle torx wrench set
 Size:T10X100,T15X100,T20X100,T25X150,T3
 0X150,T40X150,T45X200,T50X200
 Material:S2,Heat treatment and chrome plate
 Brand exclusive shelf
 Packed by double blister



LIST PRICE	Qty/Ctn
1087	10

6 Pcs insulated screwdriver set

HKISD0608

6 PCS Insulated Screwdriver Set
SL3.0x75 SL4.0x100 SL6.5x150 PH0x60
PH1x80 PH2x100 new design handle
Use Aluminum frame with 4pcs Screw
and 4pcs Screw Plug Round Shank
1000V,VDE+GS Certification Packed by
double blister

LIST PRICE	Qty/Ctn
878	24

16 Pcs insulated hand tools set

HKITH 16 01

16PCS Insulated hand tools set
1000V,VDE/GS Certification
Include:
1Pcs 200mm insulated combination pliers;
1Pcs 200mm insulated long nose pliers ;
1Pcs 160mm insulated diagonal cutting pliers;
1Pcs 160mm insulated wire stripping pliers;
4Pcs insulated slotted screwdrivers:
SL3x75mm;
SL4.0x100mm; SL5.5x125mm;
SL6.5x150mm;
5Pcs insulated phillips screwdrivers:
PH00x50mm; PH0x60mm; PH1x80mm;
PH2x100mm; PH3x150mm;

LIST PRICE	Qty/Ctn
8062	4

26 Pcs insulated hand tools set

HKITH 26 01

26PCS Insulated hand tools set
1000V,VDE/GS Certification
Include:
1Pcs 180mm insulated combination pliers;
1Pcs 160mm insulated long nose pliers ;
1Pcs 160mm insulated diagonal cutting pliers ;
3Pcs insulated slotted screwdrivers:
SL3.0x75mm; SL4.0x100mm; SL5.5x125mm;
2Pcs insulated phillips screwdrivers:
PH1x80mm; PH2x100mm;
14Pcs insulated hexagon sockets
1/2" (10mm, 11mm, 12mm, 13mm, 14mm,
16mm, 17mm, 18mm, 19mm, 22mm, 24mm,
27mm, 30mm, 32mm);

LIST PRICE	Qty/Ctn
28603	4

7 Pcs insulated open end spanners set

HKISPA0701

7Pcs insulated open end spanners set
1000V, VDE/GS certification
Include:
8mm, 10mm, 12mm, 13mm, 14mm, 17mm,
19mm;
Packed by canvas bag

LIST PRICE	Qty/Ctn
5043	10

7 Pcs insulated ring wrench set

HKISPA0702

7Pcs insulated ring wrench set
1000V, VDE/GS certification
Include:
8mm, 10mm, 12mm, 13mm, 14mm, 17mm,
19mm;
Packed by canvas bag

LIST PRICE	Qty/Ctn
5823	10

24 Pcs 1/2" socket set

HKTS12242

24 Pcs 1/2" socket set
Include:
18 Pcs 1/2"DR. Cr-V Sockets:
10,11,12,13,14,15,16,17,18,19,20,21,22,23,24,
27,30,32mm
2 Pcs 1/2"DR. Extension bar:125mm&250mm
1 Pcs 1/2"DR. Sliding T-bar:250mm
1 Pcs 1/2"DR. Universal joint
1 Pcs 1/2"DR. Quick ratchet handle
1 Pcs 1/2"DR. Flexible handle:375mm
Material:Cr-V(50BV30)
Heat treated
Chromed plated
Packed by metal box

LIST PRICE	Qty/Ctn
4907	4

20 Pcs 1/4" socket set

HKTS14201

20 Pcs 1/4" socket set
Include:
1pcs 1/4" DR. Ratchet handle,45T
13pcs 1/4" DR. Sockets:
4,4.5,5,5.5,6,7,8,9,10,11,12,13,14mm
1pcs 1/4" DR. Extension bar,2"(50mm)
1pcs 1/4" DR. Screwdriver handle
4pcs 1/4" DR. Deep hexagonal sock-
ets:8,10,12,13mm
Material:50BV30 High quality Cr-V steel
With three-color soft handle
Chromed plated
Heat treated
Packed by BMC

LIST PRICE	Qty/Ctn
1484	12

46 Pcs 1/4" socket set

HKTS14462

46 Pcs 1/4" socket set
Include:
1 Pcs 1/4" 72T quick release ratchet handle
13 Pcs 1/4"Dr Socket: 4-4.5-5-5.5-6-7-8-9-10-
11-12-13-14mm
1 Pcs 1/4"Dr Universal joint
2 Pcs 1/4"Dr Extension bar: 2"(50mm)
&4"(100mm)
1 Pcs 1/4"*150mm Spinner handle
22 Pcs 1/4" Bit socket: H3-4-5-6-7-8;T8-10-15-
20-25-30-40;SL4-5-5.5-6.5;PH1-2-3;PZ1-2-3
1 Pcs 1/4"*150mm Flexible extension bar
1 Pcs 1/4"*114mm Sliding T bar
4 Pcs Hex key wrench: 1.5-2.0-2.5-3.0mm

LIST PRICE	Qty/Ctn
2401	6

20 Pcs 1/2" socket set

HKTS12201

20 Pcs 1/2" socket set
Include:
1pcs 1/2" DR. Ratchet handle,72T
12pcs 1/2" DR. Sock-
ets:10,11,12,13,14,15,16,17,18,19,22,24mm
1pcs 1/2" DR. Spark Plug Socket:16mm
1pcs 1/2" DR. Universal joint
1pcs 1/2" DR. Extension bar:10"(250mm)
1pcs 1/2" DR. Three way joint
3pcs 1/2" DR. Deep hexagonal sock-
ets:13,17,19mm
Material:50BV30 High quality Cr-V steel
With three-color soft handle
Chromed plated

LIST PRICE	Qty/Ctn
3222	6

25 Pcs 1/2" socket set

HKTS12251

25Pcs 1/2" Socket set
Include:
1Pcs 1/2"Dr Ratchet wrench,72T
18Pcs 1/2"Dr Socket:10-11-12-13-14-15-16-17-
18-19-20-21-22-23-24-27-30-32mm
1Pcs 1/2"Dr Universal joint
2Pcs 1/2"Dr Extension Bar:125mm & 250mm
2Pcs Spark Plug Socket:16mm & 21mm
1Pcs 1/2"*250mm Sliding T bar
Material:50BV30 High quality Cr-V steel
With three-color soft handle
Chromed plated
Heat treated
Packed by BMC

LIST PRICE	Qty/Ctn
5764	4

14 Pcs E-Type socket set

HKTETS0114

14 Pcs E-type socket set
 Include:
 5 Pcs 1/4" socket:E4-5-6-7-8mm
 5 Pcs 3/8" socket:E10-11-12-14-16mm
 4 Pcs 1/2" socket:E18-20-22-24mm
 Material:Cr-V(50BV30)
 Heat treated
 Chromed plated
 Packed by BMC



LIST PRICE	Qty/Ctn
1006	20

3 Pcs 1/2" non-marring lug nut socket set

HNMLNS031

3 Pcs non-marring lug nut socket set
 Material:CrMo
 size: 17,19,21mm
 Heat treatment
 with nylon sheath
 Color mirror Processing
 Protect premium car's hub
 Packed by BMC



LIST PRICE	Qty/Ctn
1546	20

100 Pcs tools set

HKTHP21001

100 Pcs Tools Set
 Include:
 1 Pcs 1/2" ratchet wrench,45T
 18Pcs 1/2" Hexagonal Socket: 10-11-12-13-14-15-16-17-18-19-20-21-22-23-24-27-30-32MM
 2 Pcs 1/2" Extension bar:125mm (5") / 250mm(10")
 1 Pcs 1/2" Dr. Universal joint
 2 Pcs Spark plug socket 1/2"Dr.16MM&21MM
 1 Pcs 1/2"*3/8" three way adaptor
 1 Pcs 1/4" ratchet wrench,45T
 13Pcs 1/4" Hexagonal Socket:4-4.5-5-5.5-6-7-8-9-10-11-12-13-14



LIST PRICE	Qty/Ctn
11244	2

142 Pcs combination tools set

HKTHP21421

142 Pcs Combination Tools Set
 Include:
 1/2"DR.Part:
 19Pcs 1/2" Hexagonal Socket: 8-10-12-13-14-15-16-17-18-19-20-21-22-23-24-25-27-30-32MM
 5Pcs 1/2" Star Socket:E10 12 14 16 20
 1Pcs 1/2"Dr.Flex handle, 375MM
 1Pcs 1/2" ratchet wrench,45T
 2Pcs 1/2" Extension bar:75mm(3") 250mm (10")
 1Pcs 1/2" Dr. Universal joint
 1Pcs 1/2"(F)*3/8"(M) three way adaptor



LIST PRICE	Qty/Ctn
20813	1

15 Pcs 3/4" socket set

HKTS034151

15 Pcs 3/4"DR. Socket set
 Include:
 10 Pcs 3/4" socket:30-32-34-36-38-41-46-50-55-60mm
 1 Pcs 3/4" 24T ratchet handle, 1 Pcs 3/4" 500mm sliding T-bar
 1 Pcs 3/4"100mm extension bar, 1 Pcs 3/4" 200mm extension bar
 Material:Cr-V(50BV30)
 Heat treated, Cold extrusion, Chromed plated
 Packed by metal box



LIST PRICE	Qty/Ctn
15151	1

59 Pcs tool chest set

HTCS15591

59 Pcs Tool Chest Set
 Include:
 12Pcs Combination sp.:8-10-11-12-13-14-15-16-17-18-19-22MM, 8Pcs Screwdriver: SL3X75MM, 4x100MM, 5x125MM, 6x100MM, 8x200MM;PH1X80MM,PH2X100MM,PH3X200MM
 18Pcs 1/2" Hexagonal Socket: 8-10-12-13-14-15-16-17-18-19-20-21-22-23-24-27-30-32MM, 1Pcs 1/2" ratchet wrench, 2Pcs 1/2" Extension bar:125mm(5"),250mm (10"), 2Pcs Spark plug socket 1/2"Dr.16MM&21MM, 1Pcs 1/2" Dr. Universal joint, 1Pcs 1/2"Dr.Flex handle 375MM, 1Pcs



LIST PRICE	Qty/Ctn
19224	1

108 Pcs tool chest set

HTCS151081

108 Pcs Tool Chest Set
 Include:
 1Pcs Ratchet wrench: 1/4"
 13Pcs 1/4" socket 4-4.5-5-5.5-6-7-8-9-10-11-12-13-14
 2Pcs Extension bar:1/4"Dr. x 50mm,1/4"Dr. x 150mm
 1Pcs Spinner handle:1/4"x150mm
 1Pcs bit holder:1/4"*6.35mm
 20 Pcs screwdriver bits: SL3,SL4,SL5,SL6,PH0,PH1,PH2,PH3,PZ0,PZ1,PZ2,PZ3,T10,T15,T20,T30,H3,H4,H5,H6
 1Pcs Ratchet wrench: 1/2"
 1Pcs 1/2"Universal joint



LIST PRICE	Qty/Ctn
17935	1

328 Pcs tool chest set

HTCS273281

328 Pcs Tool Chest Set
 Chest part: With 7pcs drawers - Overall size:65x46x812mm
 Overall with casters size:765x465x976mm, Casters size:5"X2"
 Thickness of Cabinet:0.8-1.0mm, Thickness of drawer:0.7mm
 With 5pcs 536x410x74.5mm drawer,2pcs 536x410x153.5mm drawer
 5Pcs iron hooks(for hanger tools)
 Packed in EVA foam + carton box + Pallet
 Tools part:
 1Pcs Ratchet wrench: 1/4"
 13Pcs 1/4" socket 4-4.5-5-5.5-6-7-8-9-10-11-



LIST PRICE	Qty/Ctn
85936	1

14" Plastic tool box

PBX1401

14" Plastic Tool Box
 Size : 356mm(14")*168mm (6.6") *150mm (6")
 Material: PP
 weight: 720g
 PP plastic buckle
 Max Load : 10KG
 High-strength Handle
 Upper cover with three storage areas
 Upper cover with scale function
 Contains 1Pcs plastic tray
 Packed by label



LIST PRICE	Qty/Ctn
781	8

17" Plastic tool box

PBX1701

17" Plastic Tool Box
 Size : 436mm(17")*220mm (8.7") *205mm (8")
 Material: PP
 weight: 1390g
 PP plastic buckle
 Max Load : 15KG
 High-strength Handle
 Upper cover with three storage areas
 Upper cover with scale function
 Contains 1Pcs plastic tray
 Packed by carton box



LIST PRICE	Qty/Ctn
1154	8

20" Plastic tool box
PBX2001

20" Plastic Tool Box
 Size: 508mm(20")*296mm (11.7") *261mm (10.3")
 Material: PP
 weight: 2150g
 PP plastic buckle
 Max Load : 20KG
 High-strength Handle
 Upper cover with three storage areas
 Upper cover with scale function
 Contains 1Pcs plastic tray
 Packed by label



LIST PRICE	Qty/Ctn
1955	8

2 Pcs plastic tool boxes set
PBXK0201

2 Pcs plastic tool boxes set: 14"+17"
 14" Size : 356mm(14")*168mm (6.6")
 *160mm(6.3")
 17" Size : 436mm(17")*220mm (8.7")
 *205mm(8")
 PP plastic buckle
 Material: PP
 High-strength Handle
 Upper cover with three storage areas
 Upper cover with scale function
 Each box contains 1 pcs plastic tray
 Packed by label



LIST PRICE	Qty/Ctn
1620	6

3 Pcs Plastic tool boxes set
PBXK0301

3 pcs Plastic Tool Boxes Set : 14"+17"+20"
 14" Size : 356mm(14")*168mm (6.6")
 *160mm(6.3")
 17" Size : 436mm(17")*220mm (8.7")
 *205mm(8")
 20" Size : 508mm(20")*296mm (11.7")
 *261mm(10.3")
 PP plastic buckle
 Material: PP
 High-strength Handle
 Upper cover with three storage areas



LIST PRICE	Qty/Ctn
3320	4

Tools bag
HTBG 28 132 8

Size: 13"
 Max load: 12kg
 Size(L*W*H):33*21*18cm
 Rigid frame for easy opening and access
 external pockets for additional storage capacity
 With 6 pockets outside
 Packed by paper card



LIST PRICE	Qty/Ctn
478	40

Tools bag
HTBG 28 162 8

Size: 16" Max load: 15kg
 Size(L*W*H):41*29*21cm Rigid frame for
 easy opening and access Internal & external
 pockets for additional storage capacity With
 6 pockets outside and 8 pockets inside
 Packed by paper card



LIST PRICE	Qty/Ctn
793	20

Tools bag
HTBG 08

Size: 16"
 Material: 1680D polyester
 Max load: 20kg
 Size(L*W*H):41*25*26cm
 Rigid frame for easy opening and access
 Reinforced plastic base for durability
 Internal pockets for additional storage capacity
 Adjustable shoulder strap included
 Packed by paper card



LIST PRICE	Qty/Ctn
1630	10

Tools backpack
HBP0101

Size: L38* W17*H46cm
 Max load: 8kg
 Material: polyester oxford 600D
 Rigid frame for easy opening and access
 Internal
 External pockets for additional storage capacity
 Packed by paper card



LIST PRICE	Qty/Ctn
2481	8

Tools bag
HTBP02031

Size: 2 Pcs L26*W23cm 1 Pcs L15*W13cm
 Adjustable belt (92-127cm) 14 Pcs pockets 2
 Pcs hammer holders Max load: 10kg
 Material: 600D polyester Various pockets for
 tools Packed by paper card



LIST PRICE	Qty/Ctn
1112	20

G clamp
HGCC 104

Size:4"/100mm
 Body malleable cast iron
 T-shaped thread
 Packed by paper card



LIST PRICE	Qty/Ctn
537	

G clamp
HGCC 106

Size:6"/150mm
 Body malleable cast iron
 T-shaped thread
 Packed by paper card



LIST PRICE	Qty/Ctn
842	

Spring clamp

HQSC0204

Size:4"
 Length: 110mm
 Clamping force:12KGS
 Black clip body
 Max open mouth: 50mm
 Packed by label



LIST PRICE	Qty/Ctn
73	240

Spring clamp

HQSC0206

Size:6"
 Length: 150mm
 Clamping force:15KGS
 Black clip body
 Max open mouth: 68mm
 Packed by label



LIST PRICE	Qty/Ctn
105	120

F clamp with plastic handle

HFC0 21 20 1

Clamp size:120x300mm
 Max clamp force: 450KGS
 Thickness and width of iron ruler:8X30mm
 Diameter of screw thread:15.3mm
 Packed by paper card



LIST PRICE	Qty/Ctn
1032	10

F clamp with plastic handle

HFC0 21 20 2

Clamp size:120x500mm
 Max clamp force: 450KGS
 Thickness and width of iron ruler:8X30mm
 Diameter of screw thread:15.3mm
 Packed by paper card



LIST PRICE	Qty/Ctn
1214	6

F clamp with plastic handle

HFC0 21 20 4

Clamp size:120x400mm
 Max clamp force: 450KGS
 Thickness and width of iron ruler:8X30mm
 Diameter of screw thread:15.3mm
 Packed by paper card



LIST PRICE	Qty/Ctn
1063	6

F clamp with plastic handle

HFC0 21 20 5

Clamp size:120x600mm
 Max clamp force: 450KGS
 Thickness and width of iron ruler:8X30mm
 Diameter of screw thread:15.3mm
 Packed by paper card



LIST PRICE	Qty/Ctn
1389	6

F clamp with plastic handle

HFC0 20 50 1

Clamp size:50x150mm
 Max clamp force: 170KGS
 Thickness and width of iron ruler:5X15mm
 Diameter of screw thread:11mm
 Packed by paper card



LIST PRICE	Qty/Ctn
339	50

F clamp with plastic handle

HFC0 20 50 2

Clamp size:50x200mm
 Max clamp force: 170KGS
 Thickness and width of iron ruler:5X15mm
 Diameter of screw thread:11mm
 Packed by paper card



LIST PRICE	Qty/Ctn
349	50

F clamp with plastic handle

HFC0 20 50 3

Clamp size:50x250mm
 Max clamp force: 170KGS
 Thickness and width of iron ruler:5X15mm
 Diameter of screw thread:11mm
 Packed by paper card



LIST PRICE	Qty/Ctn
365	50

F clamp with plastic handle

HFC0 21 20 3

Clamp size:120x800mm
 Max clamp force: 450KGS
 Thickness and width of iron ruler:8X30mm
 Diameter of screw thread:15.3mm
 Packed by paper card



LIST PRICE	Qty/Ctn
1456	6

F clamp with plastic handle

HFC021404

Clamp size:140x1000mm
 Max clamp force: 550KGS
 Thickness and width of iron ruler:10X35mm
 Diameter of screw thread:17.8mm
 Packed by paper card

LIST PRICE	Qty/Ctn
2344	6

F clamp with plastic handle

HFC021401

Clamp size:140x1200mm
 Max clamp force: 550KGS
 Thickness and width of iron ruler:10X35mm
 Diameter of screw thread:17.8mm
 Packed by paper card

LIST PRICE	Qty/Ctn
2711	6

Quick bar clamp

HQBC0 16 01

Clamp size:63x150mm
 Max clamp force:60KGS
 Thickness and width of iron ruler:5X18mm
 Packed by label

LIST PRICE	Qty/Ctn
393	12

Quick bar clamp

HQBC0 16 02

Clamp size:63x300mm
 Max clamp force:60KGS
 Thickness and width of iron ruler:5X18mm
 Packed by label

LIST PRICE	Qty/Ctn
472	12

Quick bar clamp

HQBC0 16 03

Clamp size:63x450mm
 Max clamp force:60KGS
 Thickness and width of iron ruler:5X18mm
 Packed by label

LIST PRICE	Qty/Ctn
550	12

Quick bar clamp

HQBC2 48 02

Clamp size:80x600mm
 Max clamp force:135KGS
 Thickness and width of iron ruler:6X18mm
 Packed by label

LIST PRICE	Qty/Ctn
1415	8

Quick bar clamp

HQBC3 68 03

Clamp size:80x900mm
 Max clamp force:135KGS
 Thickness and width of iron ruler:6X18mm
 Packed by label

LIST PRICE	Qty/Ctn
1677	8

4 Pcs wood chisel set

HKTWC 040 1

4 pcs Wood Chisel Set
 Width:6mm,12mm,19mm,25mm
 Length:140mm
 Wood Chisel,Cr-V
 Packed by Sliding card

LIST PRICE	Qty/Ctn
1153	16

Hand riveter

HRS108

Size:10.5"
 Applicable aluminum rivet size:Φ2.4mm, 3.2mm,4mm,4.8mm
 Packed by sliding card

LIST PRICE	Qty/Ctn
414	24

Hand riveter

HR10 5

Size:10.5"
 Aluminium alloy body
 Applicable rivet size:2.4mm, 3.2mm,4mm,4.8mm
 Packed by double blister

LIST PRICE	Qty/Ctn
655	

Hand riveter

HR131

Size:13" Applicable to stainless steel,aluminum and steel rivet
 Stainless steel rivet:
 φ3.2mm,4.0mm,4.8mm,6.0mm
 Aluminum&steel rivet:
 φ3.2mm,4.0mm,4.8mm,6.0mm,6.4mm
 Hand riveter material:Steel+Aluminium
 Packed by color box

Alu&steel:
 Φ3.2, 4.0, 4.8, 6.0, 6.4mm

Stainless steel:
 Φ3.2, 4.0, 4.8, 6.0mm

Aluminium body

LIST PRICE	Qty/Ctn
1345	20

Hand riveter

HR171

Size:420mm,17"
 Applicable rivet size:3.2mm,4mm,4.8mm
 Material: Steel+Aluminium
 With Unique Design Rubber hand
 Packed by color box

Alu:
 Φ3.2, 4.0, 4.8mm

Aluminium body

LIST PRICE	Qty/Ctn
935	20

Folding hand riveter

HFOR 32 1

Size:815mm,32"
 Applicable rivet size:3.2mm,4mm,4.8mm,6mm,6.4mm
 Packed by color box

Alu&steel:
 Φ3.2, 4.0, 4.8, 6.0, 6.4mm

LIST PRICE	Qty/Ctn
1951	8

Leather hole punch

HLHP028

Punch hole sizes : 2.5mm, 3mm, 3.5mm, 4mm, 4.5mm, 5mm
 comfortable PVC handle
 30% save energy
 thickness: 2.0mm
 Packed by Half double blister

30% save energy
 Punch hole sizes (mm):
 2.5 3 3.5 4 4.5 5

LIST PRICE	Qty/Ctn
578	48

Grease gun

GRG0 15 00 1

Heavy-Duty Grease Gun
 Taiwan Quality
 Capacity: 400CC / 14Oz
 Loading way: 14Oz Cartridge / 400CC Bulk
 Working Pressure: 4500psi
 Burst Pressure: 10000psi
 Material: 1.2mm Steel tube + Aluminum-Cast
 Standard Accessory:
 1pcs 12" High Pressure Flexible Nylon Hose
 1pcs Metallic Bend Spout
 Packed by color box

400cc

Key components made in Taiwan Top quality in the world

LIST PRICE	Qty/Ctn
1252	20

Staple gun

HSG14012

staple gun
 Staples: Wire:0.7mm,
 Crown: 11.3mm,
 Length: 4-8mm
 Matched with Staple items:STS0108
 Packed by double blister

4-8mm

LIST PRICE	Qty/Ctn
507	20

Staple gun

HSG14018

Staple gun
 Adjustable driving force
 Wire:0.7mm
 Crown:11.3mm
 Length: 4-14mm
 Matched with Staple items:
 STS0108,STS0110 and STS0112
 Packed by double blister

4-14mm

LIST PRICE	Qty/Ctn
662	20

3 In 1 staple gun

HSG1405

3 in 1 staple gun
 Adjustable driving force
 Staples:Wire:1.2mm,Crown:11.3mm,Length: 4-14mm
 U-Shape Staples :
 Wire:1.2mm,Crown:6.3mm,Length: 10-12mm
 Brad Nails:Wire:1.2mm,Length: 10-14mm
 With 200pcs Staples/200pcs U-Shape Staples/200pcs Brad Nails
 Matched with Staple items:
 STS0208/STS0210/STS0212
 U-Shape Staples : STS0412

4-14mm 3 IN 1

LIST PRICE	Qty/Ctn
724	20

Light concrete saw

HCBS016001

Size:24"/600mm
 Material: 65MN
 17T (Tungsten steel tooth)
 For cutting cellular concrete/Autoclaved Fly Ash Brick /gypsum board/ice Block
 Heat treatment teeth
 Surface Electrophoretic paint Treatment
 Two color soft handle
 Packed by paper card

600mm(24")

65Mn

17T

LIST PRICE	Qty/Ctn
1256	12

Snap-off blade knife

HKNS11815

Blade Size:18mmx100mm
 With 1 pcs SK4 blade (HKNSB112)
 Length:179mm
 With flat push button
 Packed by sliding card

SK4 18x100mm

LIST PRICE	Qty/Ctn
118	96

Utility knife

HKNS11615

SK4 **19x61mm**
Aluminum Alloy

Aluminum alloy body
With 1 pcs SK4 blade (HUKB61001)
Auto-Lock
Blade:61mm(L)x19mm(W)
Packed by sliding card



LIST PRICE	Qty/Ctn
155	144

Utility knife

HUK615

SK4 **19x61mm**
Zinc Alloy

Zinc alloy body
With 1 pcs SK4 blade (HUKB61001)
Auto-Lock
Blade:61mm(L)x19mm(W)x0.6(T)
Weight:110g
Packed by sliding card



LIST PRICE	Qty/Ctn
288	72

Multi-function knife

HM FK81 58

Stainless Steel **15 FUNCTION**

Multi-function Knife
With 15 Function
1.Large knife 2.Can opener 3.Phillips screwdriver 4.Leather punch 5.Bottle Opener 6.Scissors 7.Needle 8.Slotted Screwdriver 9.Fish scaler 10.Hook remover 11.Saw 12.corkscrew 13.Nail cleaner 14.Nail file 15.key ring
Strong Aluminium Handle
Product size: 9,5cm
Packed by display color box

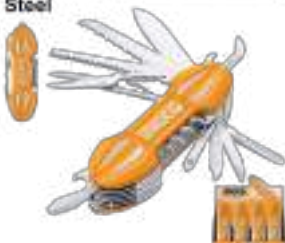

LIST PRICE	Qty/Ctn
580	48

Foldable multi-function tool

HFMFT0115

Stainless steel handle with soft rubber grip
Foldable, easy to carry, Includes 1pcs nylon belt pouch
Overall size: 155mm, closed size: 100mm
With 15 Function
1.Flat nose Pliers 2.Regular pliers 3.Wire Cutters 4.Sharp knife 5. Screwdriver 6.Bottle opener 7. Screwdriver 8. Screwdriver 9.Serrated knife 10.Wood Saw 11.Multi-functional Hook 12.Hook remover 13.Phillips Screwdriver 14.Can Opener 15.Metal/Wood File



LIST PRICE	Qty/Ctn
1184	36

Multi-function hammer

HM FH01 21

Multi-function hammer
With 12 Functions
1.Claw hammer 2.Flat nose Pliers 3.Regular pliers 4.Wire Cutters 5.Large knife 6.Wood Saw 7.Hook remover 8.Phillips Screwdriver 9.Metal File 10.Wood File 11.SL5 Slotted screwdriver 12.Hex key
Strong Aluminium Handle
Packed by double blister



LIST PRICE	Qty/Ctn
1957	24

Glass cutter

HGCT 02

Wooden handle
Glass cutter with 6pcs wheels blade
Total cutting length: 3000x6=18000mm
length:130mm
Packed by sliding card



Glass cutter with 6pcs wheels blade

LIST PRICE	Qty/Ctn
173	240

Sucker

HSU012501

Ø115mm **25KG**

Handle material: ABS
Max. pull: 25kg
Cup diameter: 115mm
Packed by color sleeve



LIST PRICE	Qty/Ctn
301	36

Sucker

HSU025001

Ø115mm **50KG**

Handle material: ABS
Max. pull: 50kg
Cup diameter: 115mm
Packed by color sleeve



LIST PRICE	Qty/Ctn
558	18

Ratchet spanner

HCSPAR 08 1

Size:8mm
Length: 140mm
Material:Cr-V
Chrome plated,matt finish
Packed by paper card



LIST PRICE	Qty/Ctn
206	120

Ratchet spanner

HCSPAR 10 1

Size:10mm
Length: 159mm
Material:Cr-V
Chrome plated,matt finish
Packed by paper card



LIST PRICE	Qty/Ctn
214	120

Ratchet spanner

HCSPAR111

Size:11mm
 Length: 165mm
 Material:Cr-V
 Chrome plated,matt finish
 Packed by paper card

LIST PRICE	Qty/Ctn
220	120

Ratchet spanner

HCSPAR121

Size:12mm
 Length: 171mm
 Material:Cr-V
 Chrome plated,matt finish
 Packed by paper card

LIST PRICE	Qty/Ctn
238	120

Ratchet spanner

HCSPAR 13 1

Size:13mm
 Length: 178mm
 Material:Cr-V
 Chrome plated,matt finish
 Packed by paper card

LIST PRICE	Qty/Ctn
248	120

Ratchet spanner

HCSPAR 14 1

Size:14mm
 Length: 191mm
 Material:Cr-V
 Chrome plated,matt finish
 Packed by paper card

LIST PRICE	Qty/Ctn
263	120

Ratchet spanner

HCSPAR 15 1

Size:15mm
 Length: 200mm
 Material:Cr-V
 Chrome plated,matt finish
 Packed by paper card

LIST PRICE	Qty/Ctn
273	60

Ratchet spanner

HCSPAR 16 1

Size:16mm
 Length: 209mm
 Material:Cr-V
 Chrome plated,matt finish
 Packed by paper card

LIST PRICE	Qty/Ctn
300	60

Ratchet spanner

HCSPAR 17 1

Size:17mm
 Length: 225mm
 Material:Cr-V
 Chrome plated,matt finish
 Packed by paper card

LIST PRICE	Qty/Ctn
314	60

Ratchet spanner

HCSPAR 19 1

Size:19mm
 Length: 245mm
 Material:Cr-V
 Chrome plated,matt finish
 Packed by paper card

LIST PRICE	Qty/Ctn
352	60

Ratchet spanner

HCSPAR 21 1

Size:21mm
 Length: 290mm
 Material:Cr-V
 Chrome plated,matt finish
 Packed by paper card

LIST PRICE	Qty/Ctn
476	60

Ratchet spanner

HCSPAR 24 1

Size:24mm
 Length: 335mm
 Material:Cr-V
 Chrome plated,matt finish
 Packed by paper card

LIST PRICE	Qty/Ctn
614	40

Ratchet spanner
HCSPAR271

 Size:27mm
 Length: 359mm
 Material:Cr-V
 Chrome plated,matt finish
 Packed by paper card

LIST PRICE	Qty/Ctn
822	30

8 Pcs ratchet spanner set
HKSPAR1082

 8pcs Ratchet Spanner Set
 High quality Cr-Mo Ratchet
 Size:8-19mm
 8mm,10mm,12mm,13mm,14mm,15mm,17mm,
 19mm
 Fine polished ,CR-V
 Packed by plastic hanger

LIST PRICE	Qty/Ctn
2049	10

8 Pcs flexible ratchet spanner set
HKSPAR1083

 8pcs Flexible Ratchet Spanner Set
 High quality Cr-Mo Ratchet
 Size:8-19mm
 8mm,10mm,12mm,13mm,14mm,15mm,17mm,
 19mm
 Fine polished ,CR-V
 Packed by plastic hanger

LIST PRICE	Qty/Ctn
2562	10

Ratchet spanner set
HKSPAR1061

 6pcs Ratchet Spanner Set
 Size:19-32mm
 19mm,22mm,24mm,27mm,30mm,32mm
 Fine polished ,CR-V
 Packed by canvas bag

LIST PRICE	Qty/Ctn
4206	4

Double socket ratchet wrench
HRSTW19211

 Size: 19x21mm
 Cr-V socket with 12 points
 Drop forged steel body
 Black finished
 Heat treatment
 Packed by paper card

LIST PRICE	Qty/Ctn
806	40

Bent wrench
HBWS09 328

 Chrome plated
 Two color handle
 Packed by sliding card
 1 Pcs double open end wrench, 9-14mm,15-
 22mm
 1 Pcs single open end wrench, 23-32mm
 Bent wrench

LIST PRICE	Qty/Ctn
534	20

Adjustable wrench
HADW 13 10 88

 Length:200mm(8"),CrV
 Adjustable clamp size:0-34mm
 Unique design two tone soft handle
 Packed by double blister

LIST PRICE	Qty/Ctn
588	36

Adjustable wrench
HADW 13 11 08

 Length:250mm(10"),CrV
 Adjustable clamp size:0-40mm
 Unique design two tone soft handle
 Packed by double blister

LIST PRICE	Qty/Ctn
809	24

Adjustable wrench
HADW 13 11 28

 Length:300mm(12"),CrV
 Adjustable clamp size:0-45mm
 Unique design two tone soft handle
 Packed by double blister

LIST PRICE	Qty/Ctn
1181	16

Ratchet wrench
HRTH0 81 4

 Size:1/4" 45T
 Length:155mm
 Material : Cr-V+CrMo
 Heat treatment
 Packed by plastic hanger

LIST PRICE	Qty/Ctn
466	80

Ratchet wrench
HRTH8412

Size: 1/2" 72T
 Length: 260mm
 Material: Cr-V+CrMo
 Heat treatment
 Packed by plastic hanger



LIST PRICE	Qty/Ctn
927	24

Foot pump
MPP5511

Size: $\varnothing 55 \times 120$ mm
 Head fits Schrader, Presta, Dunlop
 With Bar and PSI double units
 High pressure durable hose 60cm
 Steel cylinder and frame
 Rubber pedal
 Packed by color box



LIST PRICE	Qty/Ctn
1129	20

Tile cutter
HTC0 46 00

Tile cutter Max cutting length: 600mm Max cutting thickness: 12mm Steel base size: 815x195cm Thickness of the base: 2mm With 2 pcs tungsten carbide blade, Blade size: 16x6x3mm Multi-function: direct line cutting, diagonal line cutting Diameter of sliding bar: 19mm Packed by carton box



LIST PRICE	Qty/Ctn
3734	4

Tile cutter blade
HTC0 46 00B

Tile cutter blade
 Material: tungsten carbide
 Blade size: $\varnothing 16 \times 6 \times 3$ mm
 Suitable for HTC04600
 Packed by blister card



LIST PRICE	Qty/Ctn
229	50

Tile cutter
HTC0 48 00 AG

Tile cutter
 Max cutting length: 800mm
 Max cutting thickness: 14mm
 With 1 pcs bag
 Steel base size: 993x165mm
 2pcs steel support frame
 Thickness of the base: 2.5mm
 With 1 pcs tungsten carbide ball bearing blade
 Blade size: 22x10.5x2mm
 Multi-function: direct line cutting, diagonal line cutting
 With aluminium gauge
 Packed by carton box



LIST PRICE	Qty/Ctn
9432	2

Tile cutter blade
HTC0 48 00B

Tile cutter blade
 With ball bearing
 Material: tungsten carbide
 Blade size: $\varnothing 22 \times 10.5 \times 2$ mm
 Suitable for HTC04800AG
 Packed by blister card



LIST PRICE	Qty/Ctn
616	50

Tile cutter
HTC0 41 20 0

Tile cutter
 Max cutting length: 1200mm
 Max cutting thickness: 12mm
 Non-slip handle grip
 Thickness of the base: 2mm
 Diameter of sliding bar: 20mm
 Multi-function: direct line and diagonal line cutting
 Packed by carton box



LIST PRICE	Qty/Ctn
12138	2

Measuring wheel
HDMW45

Display resolution: 0.1m
 Tolerance: < 0.5%
 Measuring range: 0-9999.9m
 Wheel diameter: 320mm
 Wheel perimeter: 1000mm
 With stand
 Packed by color box



LIST PRICE	Qty/Ctn
2917	6

Test pencil
HSDT1408

Test Voltage: AC 100-500V
 Slotted size: 3x140mm
 Packed by plastic hanger



LIST PRICE	Qty/Ctn
59	360

Test pencil
HSDT2201

Test Voltage: AC 100-500V / Digital: 12-220V
 Size: 135mm*23mm*17mm
 Induction test to find phase line, ground line and breakpoint of phase line
 No need to install battery
 Packed by double blister



LIST PRICE	Qty/Ctn
135	96

AC voltage detector
VD100026

AC Voltage: 12V~1000V(High sensitivity)
48~1000V(Low sensitivity)
Frequency:50/60Hz
Alarm mode: Sound and light alarm
Flash light : White LED
Low battery indication
Auto power off
With 2pcs R03 AAA batteries
Packed by color box



LIST PRICE	Qty/Ctn
425	40

Laser distance detector
HLDD0608

Measuring Range:0.05-60m
Laser Accuracy:±2.0mm
Laser Type:635nm, <1mW, Class 2
Operating temp:-10°C ~ +50°C
Function:Distance,area,volume,height
With power off function
With 1pcs canvas bag
Packed by color box



LIST PRICE	Qty/Ctn
5081	20

Self-leveling line laser
HLL 15 65 08

Working Range: 0~15 m
Levelling accuracy:±1.5mm at 5 m
Line accuracy ±1.5mm at 5 m
Levelling time<4s, Self-levelling angle ≤4°
Laser Type 650nm, Laser Class II, <1mW
With magnet, With hanging hole
Without tripods, match with HLLT01152 tripods
With Laser Cross Function
With Horizontal and Vertical Line Function
With Cross Lock Function
With Laser Gain Function
Operating temperature: 0~+40°C
Operating temperature: 20~+70°C
Batteries AA(1.5V)*3



LIST PRICE	Qty/Ctn
5335	20

Digital multimeter
DM 601 1

Display:True RMS 2000 counts
Smart Function
AC/DC Voltage: 0.8~600V
Resistance: 600kΩ
NCV
Continuity
Auto Range
Auto Power off
With 2pcs R03 AAA batteries
Packed by Color box



LIST PRICE	Qty/Ctn
780	40

Digital AC clamp meter
DCM 600 3

Data Hold Display :6000 counts LCD with double color backlight AC
Current:4A/40A/400A/600A DC
Voltage:4V/40V/400V/600V
Voltage:400mV/4V/40V/400V/600V Resistance: 400Ω/4kΩ/40kΩ/400kΩ/4MΩ/40MΩ Capacitance:4nF/40nF/400nF/4μF/40μF/400μF/4mF
Non-contact voltage detection, Diode test, Auto power off With backlight function, With flash light function With lower battery indication function, With



LIST PRICE	Qty/Ctn
2173	20

Electrical test kit
DM 302 8

3pcs/set, including as follow:
1pcs Digital AC clamp meter
1pcs Digital multimeter
1pcs AC voltage detector
1pcs Test lead
With 6pcs R03 AAA batteries
Packed by double blister



LIST PRICE	Qty/Ctn
2462	20

Auto-darkening welding helmet
AHM009

Viewing area:90×35mm
Cartridge size:110×90×10mm
Arc sensor:2, Light state:DIN 4, Dark state:fixed shade 11
Shade control:unadjustable, Power ON/OFF:fully automatic
Sensitivity control:unadjustable,auto, UV/IR protection:DIN 16
Power supply:solar cells, re-chargeable battery, no battery change required, Switching time:1/5000s, from light to dark
Dark to light:0.15-0.45s auto
Low amperage TIG:≥20amps(DC), ≥20amps(AC)



LIST PRICE	Qty/Ctn
2259	6

Pruning shear
HPS0109

Aluminium body pruning shear blade
Handle non slip treatment
Max cutting diameter 12mm
Size:8"(200mm)
Packed by Blister card



LIST PRICE	Qty/Ctn
391	60

Plastic trigger nozzle
HWSG032

3-Way Plastic Nozzle
TPR insulated comfortable soft grip
Nylon lever
Packed by paper hanger



LIST PRICE	Qty/Ctn
270	48

Plastic trigger nozzle
HWSG092

9-spray patterns
TPR insulated comfortable soft grip
Nylon Lever
Packed by paper hanger



LIST PRICE	Qty/Ctn
354	48



Pneumatic Tools

Let's Get In Touch

Contact Us

+91 9811579961

+91 8595503657

+91 7011218105

011-47002673

Email Us

staplespackagingsolutions@gmail.com

Office Location

Plot 60, Shop No.4, Furniture Block, Kirti

Nagar, New Delhi- 110015



VISIT US at: www.spspneumatictools.com